

THE GULF FABRICS LINE  
WHOLESALE  
UPHOLSTERY SUPPLY CATALOG  
2011



FURNITURE, AUTOMOTIVE, MARINE & AIRCRAFT

**FOR ALL YOUR UPHOLSTERY NEEDS**

**GET IT FROM GULF!**

**GF**

**GULF FABRICS, INC.**

3709 N. Armenia Avenue • Tampa, FL 33607-1303

P. O. Box 7725 • Tampa, FL 33673-7725

(813) 875-2707 • Fax (813) 348-2700 • (800) 237-6677 U.S.A., Puerto Rico & U.S.V.I.

Visit Our Web Site At:

[www.gulffabrics.com](http://www.gulffabrics.com)

**EMAIL: [GULFFAB1@AOL.COM](mailto:GULFFAB1@AOL.COM)**

## OUR MARKETING POLICY

Our company's history dates back to 1926, when we first started as a wholesale upholstery supply jobber and distributor committed wholly to the furniture, automotive, R.V., marine and aircraft upholstery industry.

Our commitment remains the same today.

Our customers expect only the very best in quality and service. Since we are committed to them, we render it without compromise.

In addition to the items of supplies listed in this catalog, Gulf Fabrics, Inc. sells a complete line of upholstery fabrics and vinyls manufactured by the finest companies in the industry. Samples of which may be obtained upon request.

### **TERMS:**

COD on all shipments- FOB Tampa.

Net 10 EOM Open with prior application and approval. Past due open A/C balances subject to 1 1/2% interest per month- annual rate 18%. Out of state accounts- COD-cash or Visa/MasterCard.

### **RETURN MERCHANDISE:**

Subject to a minimum 25% handling charge plus freight charges. All returns must have prior approval.

### **CHECKS:**

Acceptable with prior application and our approval. All returned checks will be assessed a minimum \$20 charge.

### **SHORTAGES OR DAMAGE:**

Claim must be made immediately upon receipt of merchandise. Examine all merchandise carefully before cutting or putting into use. No allowance will be made after cutting or use. Any damage to packages during shipping should be brought to our attention. The shipping container must be retained in order to make claim, in most instances UPS.

### **SERVICE:**

Most orders shipped within 24 hours of receipt. Shipments Via UPS unless alternate carrier is specified. Call to inquire as to when a salesman or our delivery truck will be in your area for possible delivery.

### **PRICES:**

Subject to change without notice- Please call for current prices.

*We look forward to providing you with quality service and merchandise.*

***“Tops to Bobbins - Get it from Gulf”***

## TABLE OF CONTENTS

A	
Accord .....	8
Acrylic Stayfast Binding .....	6
Acrylic Stayfast Wireon .....	6
Adhesives .....	14
Air Tool Oil .....	34
Aqua Tite .....	17
Aqua Snaps .....	21
Auveco Products .....	25-28

B	
Belt Punch .....	17
Bindings .....	5-6
Boat Strap .....	7
Bobbins .....	37
Bolsters .....	18
Bonded Fiberfill .....	18
Bungi Cord and Hooks .....	7
Burlap .....	8
Button Machine and Supplies .....	9-10
Button Twine .....	37

C	
Cambric (Fibertex) .....	8
Carpet Fasteners .....	25
Chalk .....	29
Chisels (Ripping) .....	32
Cleaners (Fabric, Leather & Vinyl) .....	16
Clear Plastic .....	7
Clip Tools .....	32
Coils, Upholstery .....	28
Convertible Tack Strip .....	6
Cotton-Felted .....	18
Curve-ease (Ply-Grip) .....	8
Curved Needles .....	30
Cushion Seam Stretcher .....	32
Cushion Units (Marshall) .....	28
Cutters (Grommets) .....	11

D	
Dacron .....	18
Decking/Denim .....	8
Dee Rings .....	7
Door Handle Clip Remover .....	31
Dot Tools and Fasteners .....	21-24
Dura Snaps .....	10

E	
Edgewire and Clips .....	28
Elastic, Flat .....	7
Electric Tackers and Staples .....	35

F	
Fabric Protector (Vectra) .....	17
Fiber Tack Strips .....	8
Fiberfill, Bonded .....	18
Foam Products .....	18
Foam Cutters .....	19
Foxedge/Polyflex .....	13
Furniture Nails, Decorative .....	15

G	
Gel Packs .....	19
Gimp .....	12
Glides (Furniture) .....	38
Glues and Hot Glue Gun .....	15
Grommets and Dies .....	11-12
Guns-Glue .....	14

H	
Hair, Rubberized .....	18
Hammers .....	33
Headliner Clips .....	27
Headliner Listing Tape .....	12
Headliner Tucking Tools .....	31
Headrest Remover Tools .....	32
Heat Guns .....	33
Heel Pads .....	5
Hog Rings and Pliers .....	34
Hydem .....	6

J	
Jiffy Steamers .....	19
Jiffy Trim (Pinchwelt) .....	12
Jute Felt and Insulator .....	5

K	
Klinch-it Tool and Fasteners .....	38
Knives .....	31

L	
Leather-Genuine (Auto & Aviation) .....	3-4
Leather-Genuine (Furniture) .....	3
Leather Punches .....	17

M	
Mallets, Wood/Rawhide .....	33
Marine Hardware .....	20
Metal Tack Strips .....	8
Monofilament Thread .....	38
Muslin .....	8

N	
Nailer, Quick .....	15

Needles .....	30
No Sag Springs and Clips .....	27

## TABLE OF CONTENTS

<b>O</b>	
Oil Pneumatic.....	34
Oil Sewing Machine .....	33
<b>P</b>	
Panel Boards.....	13
Pillow Forms.....	18
Pinchwelt, Jiffy Trim .....	12
Pin Remover.....	29
Piping Tins .....	29
Platform Rocker Springs .....	27
Plastic-Clear.....	7
Polymatic Thread (Polyeyster).....	37
Pres-N-Snap Tools and Accessories (Hoover) .....	24
Punches .....	11
<b>Q</b>	
Quick Nailer.....	15
<b>R</b>	
Razor Blades.....	29
Regulators (Cotton).....	30
Revolving Punches.....	17
Rocker Swivels and Springs.....	38
<b>S</b>	
Screwdrivers.....	22
Seat Belt Removing Tools-Bits.....	36
Seat Cover Soft Velcro.....	31
Seat Listing-Typar .....	31
Sew Foam .....	18
Sems Vinyl Color.....	16
Shears .....	39
Shear Sharpener.....	39
Silicone Aerosols.....	17
Skirt Lining .....	8
Snap Machine .....	23
Soft Edge/Tackstrip Cover .....	8
Sponge Rod .....	12
Spray Cement (Adhesive) .....	14
Springs-Furniture (Coils).....	28
Spring Clip Pliers.....	29
Spring and Frame Edge .....	13
Spring Snaps and Slides.....	7
Spring-Pickup Truck.....	7
Spring Twine .....	37
Staples and Staple Guns .....	34-36
Staple and Tack Lifters .....	32
Steamers .....	19
Stitching Twine .....	37
Swivels .....	38

<b>T</b>	
T-Pins.....	30
Tack Hammers.....	33
Tack Lifters .....	32
Tacking Strip .....	8
Tacks .....	15
Tee Nuts .....	20
Tenax Fasteners .....	23
Thread and Bobbins.....	36-38
Timesaver Tools and Attachments .....	24
Tonneau Top Hardware .....	13
Torsion Springs.....	28
Trim and Seal.....	12
Tucking Tools.....	31
Tuftor.....	29-30
Tufting Twine.....	37
Twine .....	37
Twist Pins.....	30

<b>U</b>	
Ultra Leather HP .....	1-2
Ultrasuede HP.....	2-3
Upholstery Pins.....	30

<b>V</b>	
Velcro.....	15
Ventilators and Dies.....	11

<b>W</b>	
Webbing-Jute.....	28
Webbing-Marine .....	7
Webbing Pliers.....	28
Webbing Rubber-(Elasbelt) .....	28
Webbing-Seat Belt.....	28
Webbing Stretchers .....	28
Weldwood Glue Contact.....	14
Welt-Embossed .....	12
Welt Cord.....	13
Welt Plastic.....	12
Windlace .....	12
Wire-on .....	6

<b>Z</b>	
Zippers-Auto-Furniture-Marine.....	40
Zenda Leather Cleaning Kit.....	24

**PLEASE CALL FOR CURRENT PRICING**

**TABLE OF CONTENTS**



We Appreciate and **Thank YOU** for your business and continued support!!!!!!

U.S.A. (Puerto Rico and Virgin Islands)  
1-800-237-6677 Fax (813) 348-9540

(813) 875-2707

**SERVING THE UPHOLSTERY TRADE SINCE 1948**

**NOTES**

# ULTRALEATHER™

## Superior to Vinyl ULTRA SURFACES-ULTRA RELEVANT

Polyurethane (PU) and polyvinyl chloride (PVC) might sound similar, but they're not.

Polyvinyl chloride is environmentally indestructible and can release hydrochloric acid and other toxic compounds when burned. In addition, vinyl also contains a high level of VOC's (volatile organic compounds) that negatively impact indoor air quality (IAQ), as these contaminants cause environmental and health risks. Vinyl is listed on the EPA's warning list of materials that contribute towards indoor air pollution.

Polyvinyl chloride contains Phthalates, harmful plasticizers used to soften the texture and appearance of vinyl. Phthalates have been known to cause human health risks such as disrupting hormone activity, and have been listed on the Environmental Protection Agency (EPA) list of at-risk chemicals.

Please visit the Healthy Building Network website for more information on the PVC-free movement.

### Animal-Free/Cruelty-Free Products

Of importance to Ultrafabrics is the preservation of ecosystems and the creatures that rely on and reside in them.

Our products are a cruelty-free, socially responsible, healthy alternative to leather and animal hides.

Ultrafabrics brand products often outperform leather in abrasion test results, while still maintaining a supple aesthetic finish.

As a result of its substantially lighter weight, Ultraleather reduces fuel consumption, driving transportation costs down. (see chart below)

**Ultraleather/Brisa:**

### Less Than Half the Weight of Genuine Leather

	Ultraleather	Genuine Leather
Weight (oz / square yard)	9.3	25.0
Weight (oz / lineal yard)	13.5	37.54

### Frequently Asked Questions

**Q: What is the difference between Ultrafabrics products and Vinyl?**

**A:** Ultrafabrics brand fabrics are composed of polyurethane that is non-toxic, low VOCs and compliant with industry standards for indoor air quality. Ultrafabrics products do not contain any volatile plasticizers and stabilizers found in vinyl.

### What are the benefits of being PVC free?

**Q:** Polyvinyl chloride (PVC) is environmentally indestructible vinyl and can release hydrochloric acid and other toxic compounds when burned. In addition, vinyl also contains a high level of VOC's (volatile organic compounds) that negatively impact indoor air quality (IAQ). These contaminants cause environmental and health risks. Vinyl is listed on the EPA's warning list of materials that contribute towards indoor air pollution. What differentiates PVC from the other vinyls is the addition of the chlorine molecule (chloride "C" in PVC). Chlorine is the source of many environmental health concerns with PVC, including the generation of dioxin, a highly carcinogenic chemical produced in both the manufacturing and disposal of PVC. Due to its persistent and bioaccumulative nature, chlorine increases in concentration as it moves up the food chain to humans, thus being categorized as a persistent organic pollutants (POP's). The international treaty, The Stockholm Convention, was created to target POPs, and now prioritizes the elimination of processes that produce dioxins.

### Q: What are the environmental benefits of Ultraleather than genuine leather?

**A:** Leather production and the tanning process utilizes several toxic chemicals and produces pollution in our external environment and indoor air environments, as well as significant natural resource depletion. Tanneries have been known to release dangerous pollutants such as ammonia, mercury, lead and chromium in the form of solid waste.

### Q: What part of your materials is recycled?

**A:** Approximately 99% of our solvents are recycled in the manufacturing process.

### LEED™ CREDITS

Ultrafabrics brand textiles can help clients achieve LEED™ (Leadership for Energy and Environmental Design) certification in the area of Existing Buildings.

Credits for our product line fall under the MR Credit 4.0 Sustainable Cleaning Products and Materials.\*

All of Ultrafabrics' textiles have cleaning codes W or WS and can be cleaned using low environmental impact cleaning fluids, and many using a soap and water solution.

### Ultraleather Collection

The Ultraleather™ Collection offers beautiful, luxurious, soft surfaces with exceptional durability. Formulated with an advanced strengthening technology, Ultraleather is an intelligent alternative for applications that require the look and styling of leather. This versatile collection brings reliability and function to a timeless look.

### Ultraleather™

#### Ultraleather Collection

Ultraleather™, the original surface in the Ultraleather Collection, is perfect for situations where you want the look and feel of leather, but need a more durable and practical alternative. Formulated with high-tech strengthening components for longevity, its exceptional durability and effortless cleaning make Ultraleather the ideal Ultra Surface for high wear applications with the benefit of a soft and supple hand.



## Promessa

### Ultraleather Collection

Promessa, part of the Ultraleather™ Collection, offers a luxurious, innovative two-toned texture naturally bonded with **antimicrobial** protection. This outstanding combination makes Promessa a versatile option for a wide variety of high wear applications.

## Pearlized

### Ultraleather Collection

Part of the Ultraleather™ Collection, Pearlized delights your senses with a stylish pearl-like shimmer and liquid-like touch. Add exceptional durability to the mix, and you've got a surface that's a perfect match for active lifestyles that require supremely comfortable moments to relax and recharge.

## Ostrich

### Ultraleather Collection

Ostrich, part of the Ultraleather Collection, takes its inspiration from the world of nature. Its distinctive patterns and textures, combined with strength and durability, make Ostrich ideal for high wear applications where a sophisticated, timeless appeal is a natural choice.

## Buffalino

### Ultraleather Collection

Buffalino, part of the Ultraleather Collection, takes its inspiration from the world of nature. Its distinctive patterns and textures, combined with strength and durability, make Buffalino ideal for high wear applications where a sophisticated, timeless appeal is a natural choice.

## Pony

### Ultraleather Collection

Pony, part of the Ultraleather Collection, takes its inspiration from the world of nature. Its distinctive pony hair pattern and texture, combined with strength and durability, make Pony ideal for high wear applications where a sophisticated, timeless appeal is a natural choice.

## Ultra Lifestyle Collection

The Ultra Lifestyle Collection brings elegant design and practicality to every aspect of your life. This classic collection embraces your creativity with intriguing textures and finishes, together with the strength and durability that only Ultra Surfaces can deliver. Expressive and versatile, this collection offers options that breathe for comfort as well as innovative water-repellent technology for outdoor living applications.

## Brisa®

### Ultra Lifestyle Collection

Brisa®, part of the Ultra Lifestyle Collection, is one of our most popular fabrics. It features the first polyurethane surface with a unique ventilation system that actually *breathes*. The result of this technological breakthrough is exceptional comfort that becomes a most welcome part of your life.

## Brisa® Distressed

### Ultra Lifestyle Collection

Brisa® Distressed, part of the Ultra Lifestyle Collection, is one of our most popular fabrics. It features the first polyurethane surface with a unique ventilation system that actually *breathes*.

## Brisa® Outdoor

### Ultra Lifestyle Collection

Brisa® Outdoor, part of the Ultra Lifestyle Collection, gives you a **breathable** polyurethane surface engineered for solar endurance. It's soft, supple hand, along with its unique ability to **stay cool** and **resist fading** over extended periods of sunlight, make this the perfect choice for applications anywhere under the sun.

## Brisa® Distressed Outdoor

### Ultra Lifestyle Collection

Brisa® Distressed Outdoor, part of the Ultra Lifestyle surface engineered for solar endurance. It's soft, supple hand, along with its unique ability to **stay cool** and **resist fading** over extended periods of sunlight, make this the perfect choice for applications anywhere under the sun.

## Promessa Outdoor

### Ultra Lifestyle Collection

Promessa Outdoor, part of the Ultra Lifestyle Collection, gives you a polyurethane surface engineered for solar endurance. It's soft, supple hand, along with its unique ability to **stay cool** and **resist fading** over extended periods of sunlight, make this the perfect choice for applications anywhere under the sun.

## Pony Outdoor

### Ultra Lifestyle Collection

Pony Outdoor, part of the Ultra Lifestyle Collection, gives you a **breathable** polyurethane surface engineered for solar endurance. It's soft, supple hand, along with its unique ability to **stay cool** and **resist fading** over extended periods of sunlight, make this the perfect choice for applications anywhere under the sun.

## Ultraleather™ Outdoor

### Ultra Lifestyle Collection

Ultraleather™ Outdoor, part of the Ultra Lifestyle Collection, gives you a polyurethane surface engineered for solar endurance. It's soft, supple hand, along with its unique ability to **stay cool** and **resist fading** over extended periods of sunlight, make this the perfect choice for applications anywhere under the sun.

## Ultra Innovation Collection

The Ultra Innovation Collection lives up to its name by giving you high-tech surfaces with a high-design edge. Surfaces that combine the ultimate use of state-of-the-art technology—the likes of which you won't find anywhere else—with an array of inventive design options that allow you to stay on top of the trends, and maybe even set a few of your own. Extremely durable and exceptionally soft, these innovative Ultra Surfaces will soon become such a part of your life, you'll wonder how you ever lived without them.

## Hammered

### Ultra Innovation Collection

Part of the Ultra Innovation Collection, Hammered takes contemporary design to a new level. Giving you the exceptional combination of stylish good looks and durability, Hammered stands up to your active lifestyle. Its bulleted accent texture opens a world of possibilities to integrate unique design and appeal into your everyday life.

## Raffia

### Ultra Innovation Collection

Part of the Ultra Innovation Collection, Raffia takes contemporary design to a new level. Giving you the exceptional combination of stylish good looks and durability, Raffia stands up to your active lifestyle. Its woven grain pattern opens a world of possibilities to integrate unique design and texture into your everyday life.

## Fusion

### Ultra Innovation Collection

Fusion, part of the Ultra Innovation Collection, is every bit as revolutionary as it looks. A smooth, matte grain, both modern and spare, this surface takes on a fresh look in any environment. Naturally bonded with **silver ion antimicrobial** technology, this outstanding combination makes Fusion a versatile option for a wide variety of high wear applications. Designed to tailor easily, allowing for an array of design choices, Fusion will endure in any setting.

## Patine

### Ultra Innovation Collection

Patine, part of the Ultra Innovation Collection, brings a high sheen to your days and nights. Uncommonly **smooth** to the touch and remarkably **durable**, Patine enhances every minute of your life with its exquisite, polished appeal.

## Metro tech

### Ultra Innovation Collection

Metro tech's surface, part of the Ultra Innovation Collection, is designed with a special finish technology that gives an understated look and feel. It is designed to tailor easily - making it's luxurious matte finish a perfect surface for modern, contemporary designs. Metro tech's cool, understated neutrals evoke sophisticated comfort and harmony.

## Eco tech

### New Product

New to the *Ultra Innovation Collection*, **Eco tech** features an innovative surface with a high design edge. Created using a special finish technology based upon the matte appeal of Ultra tech, Eco tech takes on a classic pebbled styling. It combines exceptional softness with extreme durability synonymous with Ultrafabrics quality. The cool, understated neutrals which comprise the Eco tech color palette will liven up any home, office or hospitality space, making it the perfect surface for a functional yet stylish aesthetic.

## Dolce - The ultimate solution in urethane upholstery.

Formulated with a polycarbonate resin system, backed up by a seven-year hydrolytic rating and a stain-resistant high-performance wear surface (400,000 double rubs), Dolce is the ideal solution for the most demanding seating applications. Exceptional durability, superior field performance and SILVERGUARD protection are not the only benefits you will enjoy from selecting Dolce for your next upholstery project. You can choose from 27 sophisticated yet versatile color ways to fit your lifestyle and experience firsthand the remarkable touch and feel of this lambskin-like leather upholstery sure to bring comfort and elegance to any room setting.



## Ultrasuede® for Interiors

### Inherently Beautiful, Responsibly Engineered.

Nothing short of a miracle describes the value, versatility, and the extraordinary beauty of Ultrasuede®. Those who love their homes and those who make their livings designing beautiful things for the home both agree—Ultrasuede® is the preferred choice for today's interior design decisions. It is the ultimate premium fabric to stand up to all the challenges of real life. Ultrasuede® is unsurpassed in performance, beauty and, perhaps most important, ease of care. It is both child- and pet-friendly and will continue to look and feel luxuriously elegant for years to come. No wonder so many manufacturers recommend Ultrasuede® for their most popular residential furniture designs.

And nothing gives shape to great design like Ultrasuede®, the best ultra-microfiber available today. It meets the most demanding contract and commercial specifications satisfying designers' concepts from the classic to the most innovative and cutting-edge. As a wallcovering Ultrasuede® adds both a visual and a tactile dimension unmatched by any other substrate.

Ultrasuede® Ambiance features ultra-microfiber made with 100% recycled polyester

A soft, plush, suede hand

Soothing to the touch in any climate

Excellent colorfastness

Resists sagging, crocking, pilling and shrinking

Highly abrasion-resistant—exceeds 200,000 Wyzenbeek double-rubs

Spot cleans and is easily washable

Unsurpassed range of today's most sought-after colors

Animal friendly



## Alcantara® Automotive Suede

Leading auto manufacturers the likes of Audi, BMW, Mercedes, Porsche, Aston Martin, Jaguar, Lexus, Maserati, Lexus and Volvo have all come to rely on Alcantara's® to personalized their cars interiors.

Seats, trim/door panels, dashboards, consoles, door post/pillars, headliners and package trays can all be covered in elegant Alcantara®, taking full advantage of its unique physical properties.

**Alcantara® Cover** for seating is the upholstery option most in line with the latest outfitting trends and is particularly adapted to softer, rounded lines. The **Cover** fabric possesses all the physical and mechanical properties required. Currently available in 26 color in solid and in two different perforations, square and round, in four colors.

**Alcantara® Pannel** (Not recommend for seating applications) is particularly pliable and easily adapts to a variety of uses. Ideal for curved or raised surfaces such a molded trim panels, headliners and dashboards.

**ELEMENT-** Outdoor/Indoor Polyurethane that resists sunlight, salt and chlorinated water, suntan lotion and stains. Element stays comfortable to the touch, even in the hot sun.

**AURA-** Elegant and sophisticated Polyurethane with a top grain leather look

**CORK-** A Polyurethane with the organic look and texture of natural cork.

**BARON-** A Polyurethane with a Rustic weathered leather resembling the sleeve of a well worn bomber jacket.

## EMBRACE™ RECYCLED LEATHER

The recycled leather used in **embrace™** offers the look, feel, and volume of traditional leather –but without the price – **embrace™** represents a new category of furniture fabric. In aesthetic terms, this recycled leather fabric offers consumers similar colors, depth, luster, dimensional grain, and hand-rubbed layered tones as traditional leathers. The unique composite construction process delivers outstanding hand and touch along with care-free, high-performance reliability – year after year

## GENUINE LEATHER

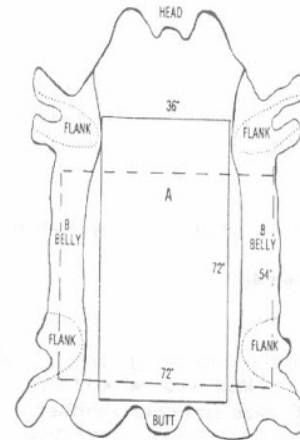

A hide of genuine leather is nature's product and caution must be exercised in cutting one. Leather should always be cut face up. The diagram shows various areas of a hide and they are cut as follows:

**Section A** should be used in cutting seat tops, inside backs, cushions bands and other sections that will receive the most strain and usage of flexing. Section A is the prime portion of a hide.

**Section B** should be used for outside arms, backs, hidden bands or any other parts of the seat that receive little or no flexing. The **flank sections** must be used on outside backs and non wearing surfaces in order to avoid trouble. As with wood, these individual characteristics and marks have been accumulated gradually during years of natural growth and form a pattern unique to each piece of hide. They are not weakening defects and will not shorten the life of the leather. You may notice one or more of the marks described below. The ability to identify and recognize them will enhance your enjoyment and appreciation of this unique item of upholstery

### How to Care for Leather

No upholstery material is easier to care for than modern leather. Dust it, wipe it occasionally with warm water and mild soap. No polish, no wax, no saddle soap. The natural oils are sealed in - buffing with a soft cloth is all the polishing it needs.

### HOW TO ORDER LEATHER

Leather is sold by the hide on a square foot basis. Whole hides run about 48-52 sq. ft. Equivalent of leather yardage to fabric yardage are shown below:

#### Square Feet in Leather (54") Fabric

17 square feet - 1 yard	34 square feet - 2 yards
51 square feet - 3 yards	68 square feet - 4 yards
85 square feet - 5 yards	102 square feet-6 yards
119 square feet-7 yards	136 square feet-8 yards
153 square feet-9 yards	170 square feet-10 yards

Leather may also be treated for FAA for additional charge. Please call for pricing.

## THE GF LINE FOR YOUR MARINE AND AUTOMOTIVE CARPET-1-800-237-6677

### CARPET 80" STRETCH BACK

Black	Graphite	Dk Gray
Med Dk Pewter	Med Graphite	Dk Blue
Med Gray	Med Neutral	Med Camel
Garnet		

**JUTE FELT**-Carpet underlay padding and noise reduction. Available in 20 oz., 36 in. width. 50 yard rolls.

**ORDER Jute Felt**

**JUTE FELT** – 40 oz carpet underlay. Available in 36 in width. 25 yard rolls.

**ORDER Jute Felt 40**

**Heel Pads** available in following sizes. **\*\* DISC \*\***

**Small 6 1/4" X 13" Medium 9 1/4" X 17 1/2" Large 13" X 17 1/2"**

**ORDER No. HP, Size and color number.**

101 Black	109 Dk Green	117 Charcoal	132 Navy
102 Lt Blue	110 Brown	120 Saddle	142 Med Blue
105 Red	112 Silver Blue	122 Dk Blue	
107 Grey	113 Gold	125 Firethorn	
108 Turquoise	115 Maroon	130 Caramel	

**Insulator- Thermal and Acoustic Protection for Cars-Trucks- Rvs-Boats and Airplanes.** Provides noise and heat reduction, moisture and wind barrier when properly installed. 48" wide.

**ORDER Insulator.....**

Cars and trucks use under hood, floorboards, headliner, doors firewall and sleepers.

- Jute side of insulator is applied to surface (Foil side up)
- Boats use engine cover, pump housings, inside hull, bulkheads, exterior walls and engine bay.
- RVs use on complete interiors, generator compartment, ceiling, and engine cover floorboard, and hot water heater.
- Aircraft-Dual sided Insulator is approved by the FAA. Use on complete interiors, Floorboard, air conditioner bay, engine cover Bulkheads, and interior skin. **(Special Order).**

**1 1/4" Bias /Binding Vinyl (One Edge Turned) Bison Grain-** Used for binding automotive carpet. **Not recommend for outdoor use.**

Color:	No:	Color:	No:	Color:	No:
Charcoal	333	Dk. Grey	311	Black	308
Lt Blue	326	Camel	324	Lt. Grey	312
Dk.Blue	325	Maroon	318	Firethorn	330
Med.Blue	328	Blue	331	White	309
Green	323	Off White	310	Oxblood	332
Red	301	Royal Blue	302	Saddle	306
Almond	329	Brown	321		

**ORDER Bison and Color Number**

**3/4" 2 Edge Turn (E.T.)**

**Bison Binding-Not recommended for outdoor use**

Roll (250 yds

1000 Yards

**1- 1/4" BIAS BINDING- VINYL**

**(ONE EDGE TURNED)**-Repp & Topp Line used for binding convertible tops and marine applications. 50 yd rolls



**ORDER Repp and Color Number**

Color:	No:	Color:	No:	Color:	No.
Black	01	Lt. Tan	555	Dk. Blue	515
Off white	178	Slate	567	White	45
Buckskin	562	Beige Tan	560	Brown	543
Maroon	564				

**Outdura 60" wide 9.25 oz 100% Acrylic outdoor fabric.** Outdura repels water and if kept clean, will not mildew. There is nothing better than Outdura for use on Awnings, Canopies and Umbrellas.

**Top Notch 60" wide 100% Polyester outdoor marine canvas.** Top Notch is the first fabric to provide all the strength and durability of high end polyester with the colorfastness, breathability, water repellency and soil release properties of solution dyed acrylics. It has superior dimensional stability which means easier sew ability and marine fabric that will not stretch or sag under wet conditions. Additionally, It is so strong that it requires limited or no reinforcements at stress points which saves the user time and money

**THE GF LINE FOR QUALITY SERVICE-TOLL FREE 800-237-6677**

**CONVERTIBLE TACKING STRIP-**

**Style "R"** 1/2" X 3/8" - Black

Cut per ft. ....  
Roll (50 ft.) ....

**Style "F"** 5/8" X 1/8"

Cut per ft. ....  
Roll (50 ft.) ....

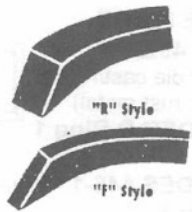

**ORDER Tackstrip Front or Rear**

**3/4" GM 2 Edge Turn ( E.T.) Repp Bias**

**Binding & Topp Line-**For outdoor use. Black, White, Off White Roll only (250 yds) .....

**ACRYLIC BINDING**

**1-1/4" OET Acrylic Binding**

**ORDER Acrylic and Color Number** Per cut yd. ....

Per yd. roll ....(100 yds per roll)....

407 Black	408 Nautical Blue	409 White
410 White	412 Navy	

**3/4 " 2 Edge Turn Acrylic binding. Matches Coastguard acrylic canvas. 100 yard rolls.**

6101 Blue	6103 Red	6108 Black
6120 Beige	6130 Grey	6131 Burgundy
6137 Forest Green		6146 Captain Navy

**CUT      ROLLS**

**ORDER 2ET & NUMBER.....**

**REDS**

**WIRE-ON BINDING**

Covers tackstrip staples on convertibles.

**Stayfast Acrylic: Vinyl:**

Black	Black -01
Burgundy	White-45
Ford Blue	Beige Tan-560
Tan	Lt. Tan-555
GM Blue	Off White-178

Mahogany (Brn.)

Black Cherry

Available in cut yardage or rolls (25 yds.).

**Stayfast Acrylic**

**ORDER WOSF and Color.....**Cut yds. (per yd.).....

Roll (25 yds.).....

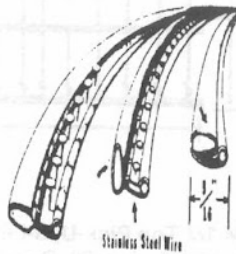

**Wire-On Binding Repp Grain-Vinyl Cuts**

**ORDER WO and Color Number** Cut yds. (per yd.)...

Roll (25 yds.).....

**HYDEM BINDING** Repp Grain and

Topp Line Available in cut yardage or rolls (50 yds.).



<b>Colors:</b> 560 Beige Tan	01 Black	515 Dk. Blue
543 Brown	178 Off White	568 Slate Grey
555 Lt. Tan	564 Maroon	

Cut Yardage.....

Roll (50 yds.).....

**HYDEM- STL 5000 or STL 5005 vinyl to match 1 1/2" marine quilted vinyl. 25 yard rolls or by the yard.**

**ORDER HYDEM AND NUMBER**

Hydem 5000 Snow White

Hydem 5005 Off White

**Cut yards..... Rolls.....**

**HYDEM - SEAQUEST Marine Hydem 25 yd rolls**

Lotion

Mist Grey

Marble Grey

Ebony

White Ice

**THANK YOU FOR YOUR BUSINESS AND SUPPORT**

**SHOCK CORD (BUNGI) & ELASTIC**

Marine grade white nylon with black markers (100' rolls). Special order item-300 ft. or 500 ft. spools.



**ORDER Bungi and size:**

1/8" Per ft.-	Cuts .....	Rolls .....
3/16" Per ft.-	Cuts .....	Rolls .....
1/4" Per ft.-	Cuts .....	Rolls .....
5/16" Per ft.-	Cuts .....	Rolls .....
3/8" Per ft.-	Cuts .....	Rolls .....
1/2" Per ft.-	Cuts .....	Rolls .....

**Flat Elastic 1"- 50 yd. rolls only (blk. or wht.)**

White-per roll .....  
Black-per roll .....

**ORDER Elastic 1 and color**

**ADJUSTABLE SHOCK CORD**

**HOOKS-** Adjust most shock hooks to any desired length easily with this plastic hook.

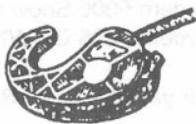

**ORDER Bungi Hooks**

Each ..... Box (100) .....Ea.

**Clear Plastic-Width 54 Inches**



16 gauge



30 gauge

Cuts 1-9 10-24 Rolls Yds. per rls

12 Ga. Clear	Interleaved	33
16 Ga. Clear	Interleaved	25
20 Ga. Clear	Interleaved	20
30 Ga. Non-interleaved-	rolls only	15

**ORDER Pla and gauge**

**BOAT STRAP Polyester ( Outdoor Quality)**

**ORDER Pel 1 White - 1" 50 yard roll (White)....**

**Polypropylene: (Not recommended for outdoor use)**

**ORDER Poly 1 White or Poly 1 Black**

- 1 50 yard roll (White).....
- 1" 50 yard roll (Black).....
- 2" 100 yard roll Black

**ORDER POLY 2 BLACK.....**

(Less 10% in lots of 10 rolls)

**DEE RINGS**

**No. 452Z-1"**  
Zinc die cast/Nickel  
(non rust metal)



Ea. Bx.(100) 1000

**ORDER D Ring 1**

**SLIDES 146-1"** Brass/Nickel  
Plated



**ORDER Slide 1**

**SPRING SNAPS**



**No. 142A-1"**

Brass/Nickel Plated

**ORDER Spring Snap 1**

**SNAPS AND RINGS**

**FOR LOOSE CUSHIONS** (non rust metal)

Zinc die cast/Nickel Plated No. 452Z-1/2" D Ring

**Order D Ring 1/2"**

**Snap Hook 1/2"**

**DS250 1/2" D Ring**

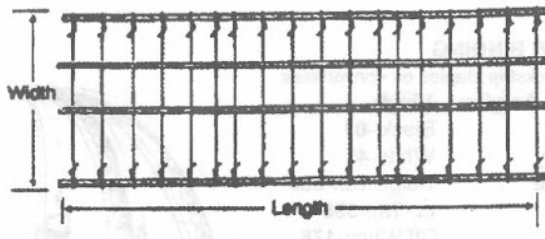

**GM 1/2 Ton Pick-Ups**-Length 50", Width 15 1/4".

Number of wires 50. Packaged 5 to box. (140210204)

**ORDER Auveco 16208.....Ea.**

**Ford Full Size Pick-Ups and Light Truck 1980-On-**

Length 52". Width 16 3/4". Number of wires 52. Packaged 5 to box. (E0tb-1063-226AC, E3TB-1063-226AA)

**ORDER Auveco 16213.....Ea.**

**Ford ranger, Courier and Yuma 1982-On-** Length 45". Width 15 3/4". Number of wires 45. Packaged 5 to box. (E27B-1063-226AC)

**ORDER Auveco 16214.....Ea.**

**PLATFORM CLOTHS**

**No. 102 Denim-Tan** in color and available in 29 or 58 inch width.

**ORDER**

**Denim 29**.....Cut.....  
Roll.....

**Denim 58**.....Cut.....  
Roll.....

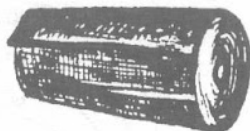

**BURLAP**

10 oz. - 40" wide Jute  
Per yd. cuts .....

Per bolt yd. ....  
(bolts contain approx. 100 yds.)

**Burlap Substitute-VERSARE**

40" wide -White  
Per yd. cuts .....

Per yd. in 100 yd. roll.

**CAMBRIC-Black Bottom**  
"Fibertex" Black 36" wide.  
1.25 oz.

**ORDER Fibertex**

Cut per yd. ....  
Per 100 yd. roll .....

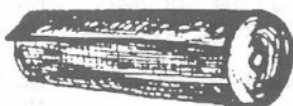

**Fibertex** Black 40" wide sold in 100 yard rolls only

**ACCORD** White 36" wide 1.25 oz.

Cut per yd. ....  
Per 100 yd. roll .....

**SKIRTLINING-** White non-woven available in 100 yard rolls.

**ORDER**

**STA-6"** .....

7" .....

8" .....

10" .....

11" .....

12" .....

**CRINOL**-Cloth woven. 100 yd. rolls

**ORDER**

**CRINOL 6"**..... **10"** .....

**7"**..... **11"** .....

**8"**..... **12"** .....

**MUSLIN** Is a natural colored unbleached utility Muslin, 64" wide

**ORDER MUSLIN**.....

(50 yd roll) .....

**C 5160A** Is a natural colored untreated duck 60" wide, 10oz material

**ORDER C 5160A**.....

(50 yd roll) .....

**BLIND TACKING STRIP**

Essential to achieve clean, straight lines in any upholstered unit. Slit from 1/32" thick Kraft board. 500 feet per roll.

**ORDER**

**Tackstrip 3/8"** .....Ea.

**3/8"** 21 or more rolls .... Ea.

**Tackstrip 1/2"** roll .....Ea.

**1/2"** 21 or more rolls ... Ea .

**FIBER TACKING STRIP - No Tack**

1/2"x36" 50 Ga. -per lb. ....

per case (approx. 28 lbs.) .....

**Order Tack Strip 36**

**METAL TACKING STRIP**

Special construction makes possible a thinner tack strip of steel. Ideally suited to lighter weight fabrics, plastics, leather or wherever a thin edge is desired. Deep cut serration's provide greater holding strength. No. 8 tack- (27" long) SlimLine.

**Order M827 and quantity**

Ea.....

50 or more.....

500 or more....



**SOFT EDGE TACK STRIP COVER**

This Clear soft protective vinyl slides over metal tack strips to prevent material from cutting.

**Order Soft Edge and size roll**

1000 ft. roll.....

100 ft. roll.....

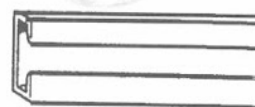

**FLEXIBLE CURVE-EASE (PLI-GRIP)**

Continuous strip invisible fastener giving a firm, smooth, tailored line around even the most radical curves without hand sewing. It blends and flexes in all directions and can also be used for straight applications. It holds the fabric smoother than hand sewing. Available in light or medium flex. 100 foot rolls packed 5 to the case.

**ORDER Curve-ease Lt. or Med.**

Each.....



**HAND BUTTON MACHINE**

This single action machine is perfect for re-upholstery and sample workshops. The ideal machine for limited production quantities. Uses simple to operate 2-piece button covering dies and short cutters. It is 19" high and has counter space of 4" x 7". Single action.

**ORDER Button Machine...**

Other models are available as Special Order Items.



**BUTTON DIES AND CUTTERS**

To produce covered buttons you need steel cutters to cut discs of the selected material, and a set of dies (shell and back) for each size button required, and a machine to which the dies are attached. Also available is the short cutter only, or the long cutter only by Special Order, in the sizes below.

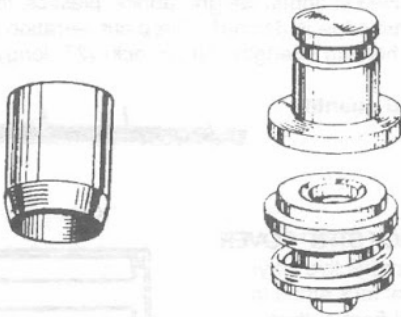

- Order Number**
- 22 Dies w/short cutter .....
  - 22 Short cutter only .....
  - 22 Dies only.....
  - 30 Dies w/ short cutter .....
  - 30 Short cutter only .....
  - 30 Dies only.....
  - 36 Dies w/ short cutter .....
  - 36 Short cutter only .....
  - 36 Dies only.....
  - 40 Dies w/ short cutter .....
  - 40 Short cutter only .....
  - 40 Dies only.....
  - 45 Dies w/ short cutter.....
  - 45 Short cutter only .....
  - 45 Dies only.....

**No. 603 PHENOLIC CUTTING PAD**

Made of resilient vinyl plastic and ideal for use with Arch punches or Belt punches. Must be used on a solid base for best results. 1/2"X10"X10"

**ORDER 603.....**

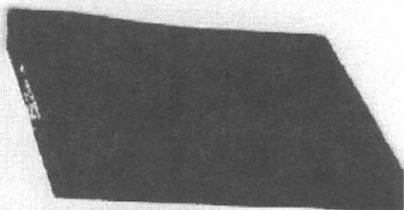

**BUTTON EQUIVALENTS**

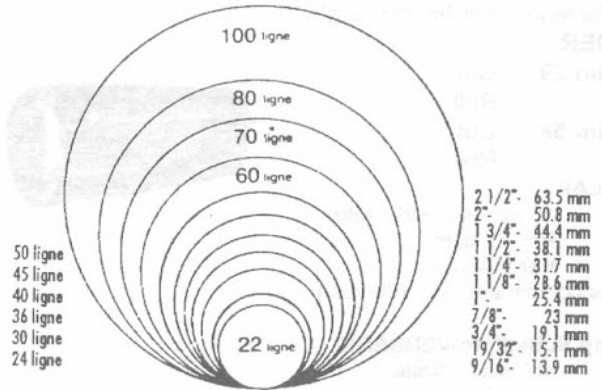

**Stock Sizes:**

- No. 22 - 9/16" -13.9mm
- No. 30 - 3/4" -19.1mm
- No. 36 -29/32" -23.0mm
- No. 40 - 1" -25.4mm
- No. 45 -1 1/8" -28.6mm

**Special Order Sizes**

- No. 24 - 19/32" -15.1mm
- No. 50 - 1 1/4" -31.7mm
- No. 60 - 1 1/2" -38.1mm
- No. 70 - 1 3/4" -44.4mm
- No. 80 - 2" -50.8mm
- No. 100 - 2 1/2" -63.5mm

**BUTTON LOOP MOLDS**

These are complete with shells and backs; available in W/E #7 (No. 44) and No. 2700 Lip-Lok Loop. They are soft shell and rust resistant; packed in 1 gross & 5 gross boxes in stock sizes.



**ORDER Size (22 etc.) Loop Molds**

- 22 Loop and wire eye (complete).....
- 30 Loop and wire eye (complete).....
- 36 Loop and wire eye (complete).....
- 40 Loop and wire eye (complete) .....
- 45 Loop and wire eye (complete) .....

**LIP-LOK**

**SHELLS ONLY**

These are soft shell and rust resistant. Available in stock sizes-1 & 5 gross bxs

**ORDER No. Size (22 etc.) Shells**

- 22 Shells (only) .....
- 30 Shells (only) .....
- 36 Shells (only) .....
- 40 Shells (only) .....
- 45 Shells (only) .....

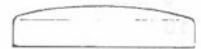

**WIRE-EYE BACKS ONLY or Lip Lok**

The W/E#7(No. 44) Wire-Eye Back has a smaller opening and is intended for use with more delicate materials.



44 W/E

The No. 2700 Lip-Lok Wire-Eye Back is best used when an extra strong bond is needed. They are rust resistant and are in 1 & 5 gross boxes. Available in stock sizes.

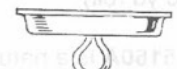

2700

**ORDER Size (22 etc.) Backs**

- 22 Backs Loop (only) .....
- 30 Backs Loop (only) .....

continued on next page

Continued from page 9

- 36 Backs Loop (only).....
- 40 Backs Loop (only).....
- 45 Backs Loop (only).....

**BUTTON MOLDS WITH NYLON HOOK BACKS**

These backs are primarily used with pre-tied twine loops to give a uniform tufting depth and faster application. The solid one-piece Hook-Back assures maximum strength and the smooth edges of the hook cannot fray twine. Loops slip easily into the special locking feature of this hook.

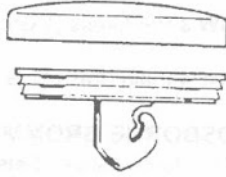

These are available in #30 only, in 1 & 5 gross boxes.

**ORDER 30 Nylon Molds.....**

**PRONG BACK BUTTON MOLDS (CLINCH)**

The Prong Back can be used in the same die as any other Back types. Tufting with Prongs is fast and easy, requiring no special skills. The Prongs are secured by simply bending them 90 degrees after insertion. These molds are complete with soft shells and rust resistant; available in stock sizes and packed in 1 & 5 gross boxes.



**ORDER Size (22 etc.) Prong Molds**

- 22 Prong (complete).....
- 22 Prong Backs only.....
- 30 Prong (complete).....
- 30 Prong Backs only.....
- 36 Prong (complete).....
- 36 Prong Backs only.....
- 40 Prong (complete).....
- 40 Prong Backs only.....
- 45 Prong (Complete).....
- 45 Prong Backs only.....

**WASHERS**

Washers are used to lock Prong Backs (Clinch) securely in place. The round Spring Washer can be used to both lock the prongs and then function as a washer.

**ORDER Prong Washers or Spring Washers**

- #1 Prong Washers for Prong
  - 5 Gross.....
  - One Gross.....
- #15 Round Spring Washers for threaded nail molds
  - 5 Gross.....
  - One Gross.....



#15

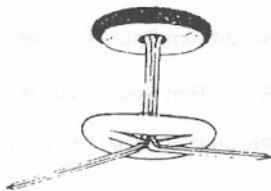

#1

**ONE PIECE MOLDED NYLON BUTTONS**

These buttons are most effective on casual/outdoor furniture or where a weather-proof button is desirable. Button has hook backs for use with pre-tied loops or rapities. Available in 1 & 5 gross boxes in No. 40 only.



**40 Style 3200-** white plastic hook buttons for outdoors (complete)

**ORDER 40 Plastic HB.....**

**ONE PIECE DURA SNAPS**

For use with Durable fastener studs. The nylon socket collet replaces the need for separate metal sockets and collets.



**No. 30 One piece dura snap**

**ORDER 30 Durasnap...**

**30 Collets (only) 1 & 5 Gross Boxes**

**ORDER 30 Collets....**

**THE GF LINE FOR YOUR GROMMETS AND SETTING TOOLS-TOLL FREE 800-237-6677**

**VENTILATORS AND DIES**

Ventilators are used as breathers for mattresses, cushions and plastic slip covers. Ventilators and Washers are made of solid brass in sizes No. 1 or No. 2. Packed in one gross boxes. Also available-Washers only, packed 100 to box.

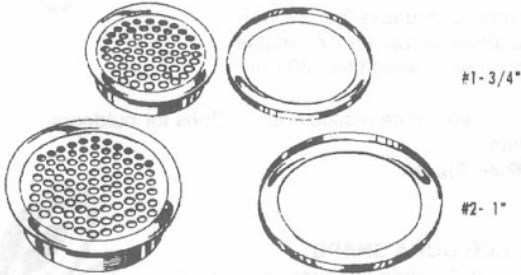

**ORDER 1B or 2B Vents**

- 1B Vents Brass w/washer (3/4") gross.....
- 1B Washers only Per 100.....
- 2B Vents Brass w/washer (1") gross.....
- 2B Washers only Per 100.....

Ventilators and Washer Attaching Die and Short Cutter for use with button machine. Short cutter only also available.

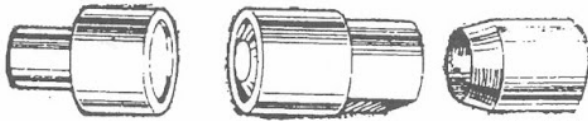

Hand Die for ventilators and Washers with Long Cutter. Long Cutter also available separately.



**Ventilator Dies w/cutter (Short)**

- 1B Dies-1 (3/4") used on button machine.....
- 2B Dies-2 (1") used on button machine.....

**GROMMETS AND WASHERS**

For use on curtains, draperies, covers, awnings, tents, sample books and displays: the broad rim of the Grommet and Washer securely anchors any material. Grommet and Washer are made of brass. Packed in one gross boxes.

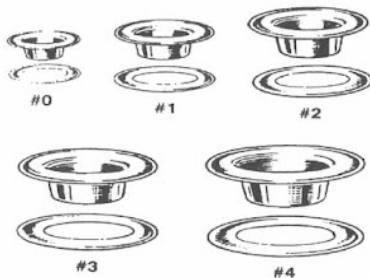

**ORDER NO. DIAMETER OF CUT**

- GW 0 Plain Brass (1 Gross).....1/4".....
- GW 1 Plain Brass (2 Gross).....9/32".....
- GW 2 Plain Brass (1 Gross).....3/8".....
- GW 3 Per Gross (1 Gross).....7/16".....
- GW 4 Plain Brass (1 Gross).....1/2".....

**OSBORNE GROMMET DIES-NO. 216**

Drop forged steel. Sets sheet brass washer or grommets.



**PLAIN GROMMETS**

**ORDER No.**

- 216 - 0 Grommet Die only.....
- 216 - 1 Grommet Die only.....
- 216 - 2 Grommet Die only.....
- 216 - 3 Grommet Die only.....
- 216 - 4 Grommet Die only.....

**GROMMET HOLE CUTTER-NO. 500**

Drop forged steel cutting punch used in connection with setting dies to cut correct size in which to insert the grommet.



**ORDER No. DIAMETER OF CUT**

- 500 "0A" Grommet Hole Cutter.....1/4".....
- 500 "1A" Grommet Hole Cutter.....9/32".....
- 500 "2A" Grommet Hole Cutter.....3/8".....
- 500 "3A" Grommet Hole Cutter.....7/16".....
- 500 "4A" Grommet Hole Cutter.....1/2".....

**ROLL RIM SPUR GROMMET AND WASHER**

Packed in one gross boxes



**ORDER No. GSW and Size DIAMETER OF CUT**

- GSW 0 Rolled Rim Spur (1 Gross).....1/4".....
- GSW 1 Rolled Rim Spur (1 Gross).....5/16".....
- GSW 2 Rolled Rim Spur (1 Gross).....3/8".....
- GSW 3 Rolled Rim Spur (1 Gross).....7/16".....
- GSW 4 Rolled Rim Spur (1 Gross).....9/16".....



**WE APPRECIATE YOUR BUSINESS**

**OSBORNE GROMMET INSERTING DIE-NO. 217**

Sets rolled rim spur washer and grommet. Packed one.



**ORDER No.**

- 217 "0" Spur Grommet Dies.....
- 217 "1" Spur Grommet Dies.....
- 217 "2" Spur Grommet Dies.....
- 217 "3" Spur Grommet Dies.....
- 217 "4" Spur Grommet Dies.....

**GROMMET KIT**

These tools are designed for occasional use. Can be used to repair awnings, tents, sails or canvas. Available in #2 grommet (3/8" hole) or #4 grommet 1/2" hole). Use of rawhide mallet is recommended.

**ORDER No.**

- K234-2 ..... 3/8".....
- K234-4 ..... 1/2".....

**KIT INCLUDES:**

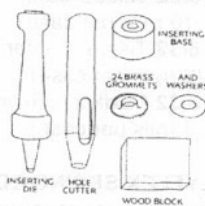

**K257-00-kit** includes #257 grommet setting pliers, #245 hole punch and one gross of #g1-00 grommets and washers. Diameter of hole when set 3/16"  
**Order K257 00**.....

**SCROLL GIMP #9940- 36 yard. bolts**

**ORDER No. Gimp & Color No.**

- Per cut yd. ....
- Per bolt yd. ....
- Per gross yd. ....
- Gimp Cards .....



**#180 Embossed Welt**

- Cut yardage .....
- Roll (100 yds.) .....
- Case (800 yds.) .....



**EMBOSSSED WELT No. 180**

Color:	ORDER No:	Color:	ORDER No:
Beige	180-16	Grey	180-8
Black	180-9	Lt Grey	180-35
Bone	180-1	Maroon	180-5
Bright Red	180-6	Med. Brown	180-17
Brown	180-18	Titanium	180-31
Buckskin	180-13	Metallic. Blue	180-10
Camel	180-15	Med Opal	180-34
Dk. Blue	180-11	Off White	180-2
Dk. Green	180-20	Rust	180-7
Firethorn	180-3	Tan	180-14
Dk. Grey	180-21	White	180-24
Burgundy	180-26	Charcoal	180-28
Med. Blue	180-25	Lt. Mocha	180-33
Sand	180-22		

**Cloth WINDLACE**

Color:	No:	Color:	No:	Color	No.
Black	178	Blue	1864	Green	1860
Brown	1980	Camel	1983	Red	1981
Forest	900	Dk. Grey	1984	Maroon	1959
Grey	1652	Navy	1982	Taupe	1414
Rust	1499	Turq	1467		

**Regular**

- Cut yardage ..... per yd
- Roll (50 yds.) ..... per yd

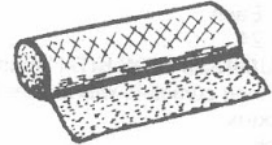

**HEADLINER LISTING TAPE**

1 1/2" Folded 100 yd. roll

**ORDER No. Listing Tape.**  
 (Less 10% in lot of 10 Rolls.)



**BLACK TRIM & SEAL-(UNI-GRIP)-A fast and easy way to**

weather-strip and trim vehicle doors and windows. Install by simply pushing over raw edges or flanges.

**ORDER ST 36A**

- 12-1/2 ft. cuts (1 door) ..
- 25 feet (2 doors) .....

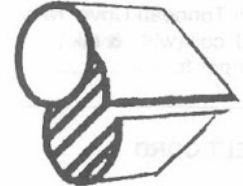

**SPONGE ROD(1/2")-50 yd. box**

**ORDER Sponge Rod**.....



**VINYLEX PLASTIC WELT**

**#730-20 Clear**-This vinyl has a clear piping-no cord.

- ORDER 730-20** Per Yd. ....
- Roll (250 yds.) .....
- 1000 yds. ....

**Vinylex Plastic Welt**-This vinyl has a clear piping with a metallic cord throughout.

**ORDER 730-33 (Gold) or 730-31 (Silver)**

- Cut yardage .....
- Roll (250 yds.) .....
- 1000 yds. ....



**JIFFY TRIM (PINCHWELT)-A flexible**

plastic windlace with metal core and leather grain surface for snap-on installation. Black only

**ORDER PW BLACK** Cut yardage .

- (33-1/3 yd) Roll (100 ft.) .....
- Jumbo Pinchwelt Black Only** (80 Ft. Box)

**ORDER PW Black Jumbo** .....



**TONNEAU COVER HARDWARE**

**ORDER No.**

**WOODEN BOWS- 72" Length**

Each .....  
Per 24 .....



**BOW SOCKETS- Chrome plated,**  
pre-drilled for No. 8 screws.

Pr. Each .....  
Per 24 .....



**ALUMINUM BOW KIT-1" round-**  
67" long complete w/brackets &  
sockets.

Each .....  
Per 10 .....



**TONNEAU COVER RAIL-**

Truck bed cover rail. 64" length,  
mill finished.

Each .....  
Per 24 .....



**BEADED WELT INSERT-Used**

with Tonneau Cover rails.

100' coil (wht. & blk.)  
Cut per ft. ....



**WELT CORD**

**Cotton Type:**

**ORDER No.**

**1341 "5/32"-Single Welt**  
(Cotton Ctr.-Per roll- 288 yds.) .....

**1342 "6/32" Single Welt**  
(Cotton Welt-Per roll- 216 yds.).....

**60010 "0" 5/32" 10 lbs. (119 yds.)**  
per lb. .... SPECIAL ORDER

**60012 "1" 6/32" 10 lbs (87 yds.)**  
per lb..... SPECIAL ORDER

**60014 "2" 8/32" 10lbs (77 yds)**  
per lb..... SPECIAL ORDER



**Polywelt Synthetic Type:**

**ORDER No. SYN and size of welt**

**Syn "4/32" 500 yd. spool (12 per case)..... Ea.**

**Syn "5/32"-500 yd. spool (6 per case)..... Ea.**

**Syn "6/32"-500 yd. spool (12 per case) .....Ea.**  
(Less 10% in case lots)

**Tissue Type:**

Braided together for double width to  
cover tack-heads or for wide-welt  
styles.

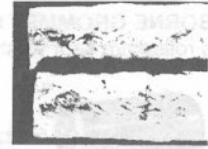

**Twin Welt:**

**ORDER No.**

**Fox 5/32 TW 5/32 Twin Welt (Tissue-250 yd.) .....**  
(10 rolls per case) .....Ea.

**Foxflex: Firm, yet pliable. Perfect cornering.**  
Has a twisted tissue core for extra firmness.

**ORDER No.**



**Fox 4/32 Tissue Center -500 yds.....**  
(14 rolls per case).....Ea

**Fox 5/32 Tissue Center-500 yds.....**  
(10 rolls per case).....Ea

**Fox 6/32 Tissue Center, - 500 yds.....**  
(6 rolls per case).....Ea

**Fox 8/32 Foxflex, 500 yd. roll .....**  
(4 rolls per case) .....Ea

**POLYFLEX SPRING EDGE OR FOXEDGE**

Clean polyester cover and filler materials are combined in this  
uniform, lightweight, strong edge.

**ORDER No.**

**Foxedge 3/4" Polyester covered Poly**  
Core. Per ft. ....  
Per roll (50 ft.) .....

**Foxedge 1-1/4" Polyester covered Poly**  
Core. Per ft. ....  
Per roll (50 ft.) .....

**Foxedge 1/2" Polyester covered Poly**  
Core Per ft .....  
Per roll (50 ft.).....

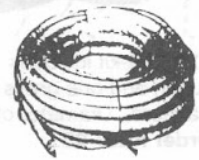

**PANEL BOARDS-**

**Order No.**

**PB 1-Plain (39" x 65")(0.070 ga.).....Ea.....**  
Each per Doz

**PB 9-Black (39" x 65")(0.070 ga.)..... Ea.....**  
Each per Doz.

**PB 7-Waterproof (32" x 48") can be shipped by UPS.**  
(.100 ga.) Ea.....  
Each per Doz.

**VB 18**

Polyethylene coated Sun Visor Board 18" x 44"  
Used to replace worn out or broken Sun Visors.  
Ea.....  
Each per Dz

**DAP LANDAU TOP AND TRIM CEMENT Weldwood No. 00234**

For bonding landau tops constructed of non-penetrable fabric backings, plastic laminates, headliners, wood, particleboard, paneling, plywood, paper honeycomb, urethane foam, aluminum mild steel and many other materials. 5 gal. Pails and gallons. Spray Grade.

Order 234 5 gal Weldwood.....

Order 233 1gal Weldwood.....

Order 272 quart. Not spray grade

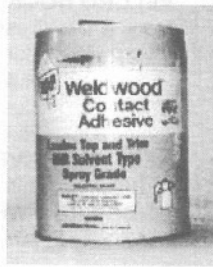

**DAP-high strength, high temperature, long open time, web spray, that bonds most woods, particle board, metal, laminate and many plastics. Ideal for use on trim work, door panels, decorative laminates and upholstery work. 16 oz. Net weight.**

Order 121 HS....."DISC"..... ea.  
12 cans per case ea.



**PERFORMANCE HIGH-TEMP ADHESIVE**

Superior bonding strength, high heat resistant contact adhesive Ideal for bonding numerous automotive, marine, and industrial materials, including lightweight headliners, carpets, foams.

- Adjustable Nozzle for controlled placement of adhesive
- No ozone depleting substances
- No chlorinated solvents

ORDER PER 394..... ea.  
Each per case..... ea.

**Misty Heavy Duty Adhesive-Wide web Spray-High Solids, No Chlorinated solvents (Not for Headliners)**

17 oz Net Wt . 12 oz

Order 315-20 ..... ea.  
12 cans per case..... ea.



**EZE SPRAY GUN- FOAM GLUE GUN**

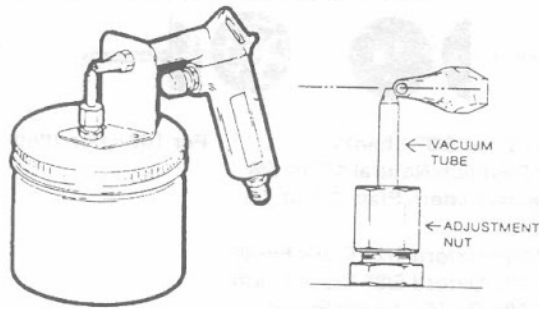

Eze Spray Gun is designed for use with Siphon type adhesives. They come with male coupler plug, ready to attach to your air line.(Accessories and parts. available)

- EZE to handle, lightweight & durable.
  - EZE to clean
  - EZE to adjust spray pattern
- Order EZE.....

**TB-02 Eze spray gun w/ aluminum (pint) cup .**

Sprays contact adhesives only, not suitable for Non-flammable adhesives. Top quality cast alum body, Brass fittings, Spun alum cup w/ stainless steel p/u tube.  
ORDER TB 02.....

**PRO 3501 Natural contact adhesive, spray grade. For use on Headliners, Carpets, Etc. (1 gal)**  
ORDER PRO 3501

**PRO 3601 Natural foam adhesive, spray grade. Not recommended for use on Headliners (1 gal)**  
ORDER PRO 3601

**PRO 416 High Pressure spray gun w/ quart cup**  
Sprays contact adhesive only

**SOLID BRASS HEAD UPHOLSTERY NAILS**



Brass- (1/2" or 5/8" Shank) Per 100 Per 1000  
 ORDER 9 French Natural 1/2 or 5/8  
 No. 9 Nickel Plated- Plain 1/2 or 5/8  
**Hammered**  
 ORDER 909 Oxford 1/2" Brass Finish  
 ORDER 909 Oxford 5/8" Brass Finish  
 ORDER 909 Ox 1/2" Nickel Plated  
 ORDER 909 Ox 5/8" Nickel Plated  
 ORDER 19 Nickel Plain 1/2

**STEEL UPHOLSTERY NAILS (1000 Per Box)**  
 ORDER OX 1909 1/2 Steel nails with a hammered natural finish  
 ORDER NAT 1009 1/2 Steel nails with a plain brass coat finish

**Holland UPHOLSTERY TACKS**-blued, sharp pointed tacks.

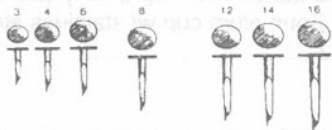

**Upholsterers:** 1 lb box  
 No. 3  
 No. 4  
 No's. 6 & 8  
 No. 12 & 14

**Webbing:**  
 No's 16

**ORDER Tacks and size**

**HOT GLUE GUN**  
**Arrow TR-550-**  
 Check valve controls glue flow. High volume melt chamber for fast and steady even application. Interchangeable nozzle.



**ORDER TR 550**.....

**HOT GLUE STICKS-10"**  
 By the lb. or 25 lb. case-

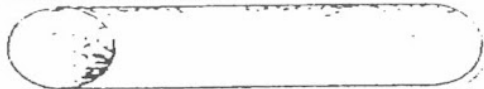

Clear 10" sticks Per Lb. Per Lb. 10 Lbs  
**ORDER 10 CLEAR**

**VELCRO HOOK & LOOP CLOSURE**

Hook & Pile Closure. 25 yard spools. White or Blk.  
 1" - Per Yd. Cut ..... per side  
 Roll..... per side  
 2"- Cut ..... per side  
 Roll..... per side

**SELF ADHESIVE Hook and Loop (VELCRO)**  
 1" Black or White 25 yd rolls (Roll only)  
**ORDER PS 1 WHITE OR BLACK**

**QUICK NAILER #777**

Set up to 5 nails head to head at one time without damaging the furniture or your fingers. Exact spacing at the same time.

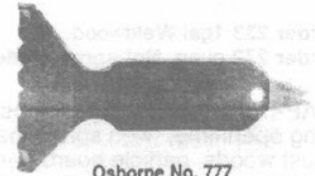

Osborne No. 777

**ORDER 777**.....

## SEM COLOR COAT AEROSOLS

- Spray coating for vinyl tops, vinyl upholstery, flexible and rigid plastics, leather, carpet and velour.
- Is designed for spray only and is stocked by Gulf Fabric in aerosols only.
- Is formulated to enhance and restore faded carpet color, not to do a drastic color change.
- Is formulated to refinish flexible plastics such as dashes, consoles, kick pads, etc., most semi-rigid and rigid plastics. (12 per case)

ORDER Sem and Color Number..... ea.

01 Landau Black	143 Lt Oak	253 Lt Taupe
023 Lt Graphite	153 Med Beige	273 Mild Beige
033 Lt Parchment	163 Md Dk Pewter	283 Oak
063 Med Prairie	183 Med Neutral	31 White
083 Dark Graphite	203 Shale	323 Creamy White
103 Dark Gray	23 Gloss Black	353 Silver Gray
133 Lt Neutral	24 Satin Black	

## SEM MARINE VINYL COLOR COAT AEROSOLS

Sems marine vinyl coat, for use on plastic and vinyl.  
With improved UV protection

M003 Ultra Purple	M133 Carver Lt Tan
M013 Ultra Turquoise	M143 Chaparal Beige
M023 Ranger Orchid	M153 Stingray Taupe
M033 Ultra Blue	M163 Ranger Beige
M043 Ranger Admiral Blue	M173 Ranger Charcoal
M053 Ranger Black	M183 Ranger Gunmetal
M063 Ranger White	M193 Light Gray
M073 Ranger Off White	M203 Formula Boat Gray
M083 Carver White	M213 Carver Coco
M093 Sea Ray Mystic White	M223 Stingray Yellow
M103 Sea Ray Alabaster	M233 Formula Boat Red
M113 Sea Ray Champagne	M243 Sterling Burgundy
M123 Carver Dade Bisque	

## SPRAYWAY MINK OIL VINYL LEATHER FABRIC CLEANER

This mink oil cleans vinyl of stains, smudges, fingerprints, general soil and dirt. Easy to use- just spray on, let stand for a couple of minutes and wipe off. Protects and preserves.

Ea. OR BY THE CASE (12)  
ORDER 990...Each...  
Each per 12 case.....



## GUARDSMAN AFTA CLEANING FLUID

Cleans clothes, carpets, upholstery, draperies, auto interiors, machine parts and tools. AFTA removes grease, tar, paint, lipstick, oil, chewing gum, wax adhesive, crayon and heel marks.

ORDER 4104...Quart...  
ORDER 4103...Gallon..



Vinyl Prep-cleans soil and grease for all vinyl surfaces. Also slightly softens the surface preparing it for excellent adhesion of top coat. Non-flammable. Works without excessive scrubbing. Available in quarts.  
ORDER Sem 38344.....



**AQUA-TITE SILICONE WATER REPELLENT**-A premium grade heavy duty solution containing 10% silicone. It restores the water repellency of Cotton or synthetic fabrics. It can be used on flame resistant fabrics without affecting the flame resistant properties. For use on fabrics of: acrylic, cotton, nylon, polyester, and cotton blends.



**32 oz. Pump bottle** EACH OR BY THE CASE  
**GALS EACH OR BY THE CASE** Each Ea. Case  
**ORDER Aqua Tite Quart**.....  
**ORDER Aqua Tite Gallon**.....

**THE WORLDS BEST CARPET AND UPHOLSTERY PROTECTOR- VECTRA-22**-A DEEP PENETRATING SPRAY ON PROTECTOR FOR SELF APPLICATION SAFE TO USE ON ALL THE FINE FABRICS IN YOUR HOME, EVEN SUEDE AND LEATHER.



**VECTRA- 22** PROTECTS AGAINST HOUSE HOLD STAINS. COFFEE, TEA, WINE, GREASE EVEN PET STAINS. MAY BE SPRAYED OVER ALL OTHER FABRIC FINISHES. WITH VECTRA' 22 LESS IS BEST-YOU NEED A GENTLE MISTING. VECTRA' 22 ENHANCES DURABILITY AND CLEANABILITY OF CARPETS, AREA RUGS, UPHOLSTERY AND AUTO INTERIORS. AS ADVERTISED IN HOUSE & GARDEN AND VOGUE MAGAZINE

**VECTRA- 22 FOR THE LIFE OF YOUR FABRICS ... VECTRA-IZE.**

**Rate of coverage**

1 Gallon will cover: 10-12 Sofas or 15 Arm Chairs or 20 Ottomans

**ORDER Vec 1** for 12 oz aerosol Can

**ORDER Vec 2** Quart for quart bottle with sprayer.....  
 Less 5% for case purchase.

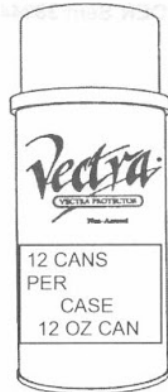

**VECTRA-INSTANT SPOT REMOVER**

Spots vanish before your eyes! Excellent for Upholstery, Carpets, Woodwork and all Washable Clothing.

- **Non-Toxic**, non irritating to normal skin.
- **Non-Flammable**, Contains no solvents of any kind.
- **Safe** for any colorfast upholstery or carpet.
- **Odor free**, no unpleasant chemicals.
- **Simple to use**, spray generous amount of **VECTRA**, agitate with your fingers and blot with absorbent cloth. No rinsing or vacuuming.
- **Non-magnetic**, will not leave sticky residual to attract more dirt. Contains no soap which stays on carpeting, attracting soil and creating a new spot.

**ORDER Vec 4** for quart bottle with sprayer.....



**Misty All Purpose Silicone spray**

- Heavy Duty Silicone
- Thick viscosity
- Does not cause gumming
- lubricates, protects
- No chlorinated or fluorinated solvents
- Net wt. 11 ozs. 12 can per case

**Order 325-16**.....Ea.  
 Each by the case..... Ea.

**OSBORNE REVOLVING PUNCH #155**-This punch is made

**PUNCHES**

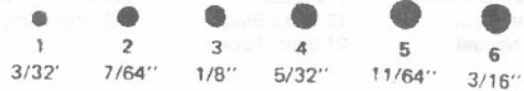
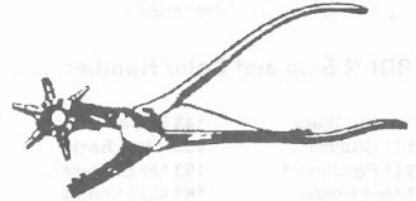

of forged steel, highly polished. The cutting tubes are hand turned from high carbon tool steel and treaded to allow easy replacement. Tubes are individually tempered and polished. Length of punch is 8 1/2".

**ORDER 155**.....

**Extra Tubes for punch are available**.....Each

**Extra Anvil**..... Each



**BELT PUNCH-Size 2**-This punch is forged from the best grade tool steel, careful hardened and tempered, with polished barrel. Hole tapers back from the cutting edge so that the punchings clear freely and require only a light blow with a mallet to cut with ease. Diameter of cut is 1/8".

**ORDER 147**.....

## YOUR POLYFOAM AND FOAM CUTTING HEADQUARTERS

### POLY FOAM SHEETS

Polyurethane



**ORDER Foam,**

Thickness, and L32,H24, H32, or H45

L32/P22 Economy/30# Compression- 1.0 Density

1/4" X 24" X 84".....

1/2" X 24" X 84".....

#### E35 Med Density 1.8#

1" X 24" X 84".....

2" X 24" X 84".....

3" X 24" X 84".....

4" X 24" X 84".....

5" X 24" X 84".....

#### E27 Soft Density /1.8#

3" X 24" X 84".....

4" X 24" X 84".....

#### H32 Med. Supreme/34# Compression/2.0 Density

2" X 24" X 84".....Special Order.....

3" X 24" X 84".....Special Order.....

4" X 24" X 84".....

5" X 24" X 84".....

#### H45 Firm Supreme/48# Compression/2.0 Density

1" X 24" X 84".....

2" X 24" X 84".....

3" X 24" X 84".....

4" X 24" X 84".....

5" X 24" X 84".....

#### Special Order fabrications available -

Cut and shaped.

E35 Per bd. ft.-1".....

H24 Per bd. ft.-1".....

H32 Per bd. ft.-1".....

H45 Per bd. Ft.-1".....

#### FOAM BOLSTERS

Polyurethane

#P22 4"x8"x12"x36".....

5"x9"x12"x36".....

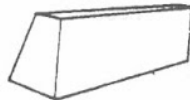

Special Sizes also available- made to order.

#### PLAIN FOAM ROLLS

1/4"x54"x45'- Rolls only.....

1/2"x54"x45'- Rolls only.....

1" x54" x45' Rolls only.....

#### SEW FOAM ROLLS

1/4"x54" Fabric Backed Foam

Cut..... yd.

Full Roll (approx. 50 yds.)..... yd.

1/2"x60" With Firm Foam

Cut..... yd.

Full Roll (approx. 23 yds).. yd.

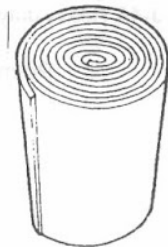

### RUBBERIZED CURLED HAIR Medium Density.

Extremely light with cotton-net backing.

1"x24"x75' per lineal foot.....

Per foot by the roll.....

#### ORDER Hog Hair

#### COTTON FELT-No. 1 Grade

(20% Dacron and 80% Cotton)

Per roll (Approx. 15 lbs.) Lb....

Per Box 3 rolls.....Lb....

Per Bale 8 rolls.....Lb....

#### Order Cotton White



#### Polyester: Dacron-No. 6 Serenity-

Plain Unbonded roll- 27" wide

#### ORDER Dacron Plain

Per LB.....

2 or more rolls- Per LB.....

(Approx. 15 lbs per box)

#### Bonded Fiberfill/Dacron 3/4 oz.. 27" wide 54" wide

1 roll (20 yds) Per lb

2 rolls Per lb.

4 Rolls bales

#### ORDER Fiberfill 27 or 54

( Prox 8 lbs & 20 yds Per roll)

#### DECORATOR PILLOW FORMS

100% polyester (less 5%, orders of \$ 100 or more,)

Each Full Case

#### ORDER Pillow and size

12" x 12" 20 pcs.

14" x 14" 20 pcs.

16" x 16" 18 pcs.

18" x 18" 15 pcs.

20" x 20" 12 pcs.

22" x 22" 10 pcs.

24" x 24" 8 pcs.

26" x 26" 6 pcs.

28" x 28" 6 pcs.

30" x 30" 6 pcs.

\* You may order different sizes to qualify for discount.



ASK ABOUT OUR SPECIALS ON SEW FOAM

**THE GF LINE FOR FOAM CUTTERS AND STEAMERS 1-800-237-6677**

**GEL PADS**-Ideal shock absorbing, and pleasure enhancing gel for wheel chairs, motorcycle seats, etc. to provide superior cushioning protect soft tissue with no edge discomfort.

Gel 1/2" (12" x 17").....

Gel 5/8" (12"x 12").....

Raw gel sheet covered w/ white lycra 3.0

**ACU-CUTTER FOAM SAWS-**

- Long lasting and affordable
- 3.2 Amp motor with variable speed
- Lightweight, trim line design
- Dual 8-inch blades
- Detachable, low profile base with glide rollers
- Fully Assembled and ready for use
- One year warranty



**ACU-CUTTER 350-**

Designed with economy and quality in mind, the **350 model** has dual blades, one moving and handles many of the tasks more expensive models perform.

**ORDER ACU 350.....**

Replacement set of dual blade also available

**ORDER ACU BLADE.....**



**JIFFY STEAMERS**

J-2 model features a solid brass heating element for steam within 2 minutes, a cast aluminum housing for durability, a shatterproof water bottle, and it supports a number of attachments for dozens of jobs.

**J-2 model shown**

Call for prices on parts.



**J-4A STEAMER Built-in easy to read sight gauge also indicates sediment build-up**

- Cast aluminum housing unit for added durability.
- Corrosion-proof stainless steel boiler tank.
- Dual thermostats for steam in seconds.
- Safety wiring feature turns the unit off temporarily when it runs dry.
- Numerous available attachments.
- Metal pipe head with wand 7 1/2 foot hose.

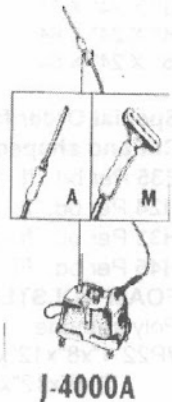

**ORDER**

**J-2** Light Duty Steamer.....

**J-4A** Heavy duty automotive Steamer.....

Reimer steamer & parts are available

\*\*\*SPECIAL ORDER\*\*\*

\*\*\* CALL FOR PRICING\*\*\*



**BOAT TOP HARDWARE**

**NYLON MARINE FITTINGS**



#401  
Small Camel Back



#402  
Eye End- Inside



#405  
Large Camel Back



#406  
3/4" Jaw Slide



#407  
Pad Eye



#416  
3/4" Slide on Eye End



#417  
7/8" Eye End- Inside



#418  
7/8" Jaw Slide



#419  
7/8" Slide on Eye End



Tee Nuts  
1/4" or 5/16"

- |                             |      |       |      |
|-----------------------------|------|-------|------|
| ORDER No. Mar and No.       | 1-24 | 25-99 | 100+ |
| #401 Small Camel Back       |      |       |      |
| #402 Eye End-Inside         |      |       |      |
| #405 Large Camel Back       |      |       |      |
| #406 Jaw Slide 3/4"         |      |       |      |
| #407 Pad Eye                |      |       |      |
| #416 Slide-on Eye Inside    |      |       |      |
| #417 7/8" Eye End Inside    |      |       |      |
| #418 7/8" Jaw Slide         |      |       |      |
| #419 Slide-on Eye           |      |       |      |
| #780 7/8" Sun Blocker Clips |      |       |      |

**T Nuts (Steel)**-recommended for indoor wood construction by providing a steel thread in wood or plywood. (100 PER BOX)  
 1/4"....."DISC"..... See Auveco 11324.  
 5/16"....."BEING DISCONTINUED".  
**Stainless steel Tee-Nuts** are available on a special order basis by the box. 50 per Box. Call for pricing.

**SIDE-RELEASE BUCKLES 1" - New from YKK**

- 300 lbs average at 1" makes these the highest strength side-release buckles available
- Non Slip adjuster ensures secure restraint
- UL approved to type 2, 3 and 5R PFD industry
- Meets Military specifications
- Sleek, stylish, high-tech design
- 4-position lock mechanism provides added safe
- Inner rib increases impact resistance



ORDER BUCKLE 1.....

**K229-20 (Baby Snaps) or K229-24 (Standard Snaps)**

Includes parts to complete six 5/8" standard nickel plated brass snaps or 1/2" along with flaring tool and die. Comes with instructions on back of hang up display card.



ORDER K229 20.....  
 ORDER K229 24.....

**K230** - An easy to use hand snap set. Snaps are nickel plated brass. Set comes with 25 complete standard 5/8" snaps, flaring tool and two dies (conclave and stud).



ORDER K230.....

**THE GF LINE FOR YOUR DOT FASTENERS-TOLL FREE 800-237-6677**

**DOT FASTENERS**

Extremely long life heavy-duty medium size button type. Heavy wire spring built directly into socket holds grip through years of hard use. Easy to attach with DOT hand tools or hand press.



**Baby Durables-**

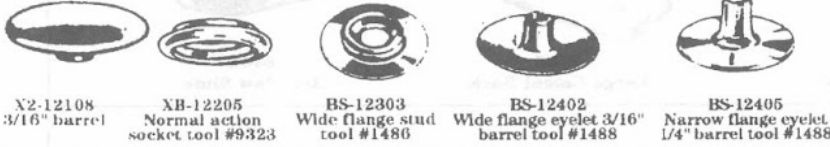

X2-12108 3/16" barrel  
 XB-12205 Normal action socket tool #9323  
 BS-12303 Wide flange stud tool #1486  
 BS-12402 Wide flange eyelet 3/16" barrel tool #1488  
 BS-12405 Narrow flange eyelet 1/4" barrel tool #1488

**Regular Durables-**

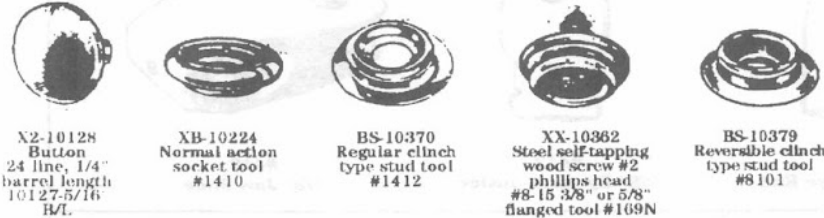

X2-10128 Button 24 line, 1/4" barrel length 10127-5/16 H/L  
 XB-10224 Normal action socket tool #1410  
 BS-10370 Regular clinch type stud tool #1412  
 XX-10362 Steel self-tapping wood screw #2 phillips head #8-15 3/8" or 5/8" flanged tool #169N  
 BS-10379 Reversible clinch type stud tool #8101



XX-10388 for 3/4" molding  
 XX-10391 for 7/8" molding  
 ST/ST windshield  
 X8-10393 Stainless wood screw #2 phillips #8-15 3/8" or 5/8" flanged tool  
 BS-10412 eyelet 1/4"  
 BS-10413 eyelet 5/16" barrel  
 XB-10708 Stud

**AQUA-SNAPS DURABLE IN COLORS**

Available in a spectrum of 8 marine colors: Black, white, Ocean Gray, Dk. Maroon, Hemp Beige, Bay Brown, Neptune Blue, Navy. Solid Delrin covered - not painted.

EACH PER 100 PER 1000

**BABY DURABLE ORDER**

- X2-12108 Button 3/16"
- XB 12205 Socket
- BS 12303 Stud
- BS 12402-Eyelet 3/16"
- BS 12405 Eyelet 1/4"

**DURABLE FASTENERS (REGULAR)**

- X2 10127 (N/B)
- X2 10128 (N/B)
- XB 10224 (N/B)
- XX 10362-12-20
- BS 10370 (N/B)
- BS 10379 (N/B)
- BS 10412 (N/B)
- BS 10413 (N/B)
- XB 10708-12-20
- XX 10388
- XX 10391

**STAINLESS STEEL**

- X2 10128SS
- XB 10224SS
- BS 10370SS
- X8 10393-12-20
- BS 10412 SS

**AQUA-SNAPS DURABLE IN COLORS**

**ORDER Aqua and color**

**COMMON SENSE FASTENERS-Locks reliably.** Spring attached to knob holding it fast under tension, yet can be instantly released by simply turning the button. Quickly attached with simple attaching tools.



BS-78502 washer for turnbutton Tool #9577  
 BS-78403 regular pronged eyelet 15/64" Tool #450  
 BS-78404 long pronged eyelet 5/16" Tool #450

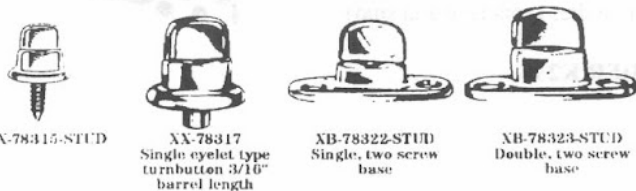

XX-78315-STUD  
 XX-78317 Single eyelet type turnbutton 3/16" barrel length  
 BS-78322-STUD Single, two screw base  
 BS-78323-STUD Double, two screw base



XB-78332-STUD single, two prong clinch  
 XB-78507-STUD clinch plate for XB78332 and XX78333  
 BS-78505 washer for BS78403 BS78404 eyelets



XB-78324-STUD single, wood screw #7x 5/8"  
 XB-78325-STUD double, wood screw #7x 5/8"

**COMMON SENSE FASTENERS**

**ORDER Each Per 100 Per 1000**

- BS 78502
- BS 78403
- BS 78404
- XX 78315-20
- XX 78317
- XB 78322
- XB 78323
- XB 78332
- BS 78507
- BS 78505
- XB 78324-20
- XB 78325-20

**THE GF LINE FOR DOT FASTENERS TOLL FREE 1-800-237-6677**

**LIFT-THE-DOT FASTENERS** Rugged. Heavy-duty. Reliable. Locks fast on three sides, then unfastens with ease when DOT (embossed on trademark) is lifted at the fourth side. Attaches fast with simple attaching tools.



**BS-16349-Stud**  
Single, two prong clinch



**BS-16501-Washer**  
For studs BS-16349



**XB-16358-Stud**  
Single, eyelet type



**XB-16302-Stud**  
Single, large hexagon base, 8-32 or 10-32 machine screw, 3/8" or 5/8" long



**XX-16366-Stud**



**X8-16360-Stud**



**XB-16509-Washer**  
For studs XB-16358



**XB-16317-Stud**  
Single, brass wood screw, #8x3/8" or 5/8"

**LIFT-THE-DOT FASTENERS**  
**ORDER**      Each    Per 100    Per 1000

- XX 16205
- XX 16206
- XB 16317-12-20
- BS 16349
- XB 16358
- XB 16362-12
- XX 16366-12-20
- BS 16501
- BS 16506
- BS 16509
- X8 16360-16SS- STAINLESS

Speedy Rivet Cap-BS 99972    Speedy Rivet Eyelet-BS 22405

**DOT HAND TOOLS**



**Setting Punch**  
#164



**Screw Driver**  
#169N



**Bench Die**  
#9936



**Bench Die**  
#9937



**Cutting Punch**  
#171



**Cutting Punch**  
#450



**Cutting Punch**  
#9951



**Screw Driver**  
#169B

- ORDER**
- UCS IT KIT**.....
- #164 Set punch for durables .....
  - #169N Screwdriver-durable screw studs .....
  - #450 Punch for 78403, 78404.....
  - #1407 M100 Die for 10412, 10413, 10414.....
  - #1412 M100 Die for 10370 .....
  - #1486 M100 Die for 12108 .....
  - #9323 M100 Punch for 12205, 12206 .....
  - #9937 Bench die for 10127, 10128 .....
  - #9941 Setting punch for 16509 .....
  - M370 Hand Press** takes M1 tool .....
  - #169B Screwdriver- Large hex. LTD studs .....
  - #171 Punch for 78333, 78332, 16349.....
  - #1401 M100 Die for 10127, 10128 .....
  - #1410 M100 Punch for 10224 .....
  - #1483 M100 Die for Baby Durable 12105 .....
  - #1488 M100 Die for 12402, 12404, 12405 .....
  - #9936 Bench Die for 10412, 10413 .....
  - #9940 Bench Die for 16358 .....
  - #9951 Cutting tool for 16205, 16206 .....

**THE GF LINE FOR TENAX FASTENERS AND TOOLS TOLL FREE 1-800-237-6677**

**SNAP LOCKING FASTENERS (TENAX)**

The Tenax fastener is a self-locking fastener which cannot come undone once engaged on it's peg unless subjected to extreme force. A quick release is accomplished simply by pinching the head of the button. All components are non-rust, made from non-ferrous materials which are nickel-plated. Nut #302 is designed to accommodate various thickness of canvas or other materials. Tenax fasteners have been used for car soft-tops and Tonneau covers, loose covers, car carpets, bags and equipment cases and tents, in fact, wherever a compact and secure fitting is required.

**ORDER**

- #31/302 Button & Nut (per set...  
 Tenax #31 Button Only.....  
 Tenax #302 Nut Only.....  
 Tenax #11 Wood Stud.....  
 Tenax #34 Key.....  
 Tenax #15 Machine Stud.....



#34 Locking Key



#31 Button



#11 Woodscrew Peg



#15- 3/16" Machine Peg



#302 Button Locking Nut

**ATTACHING PRESS**

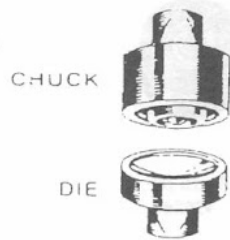
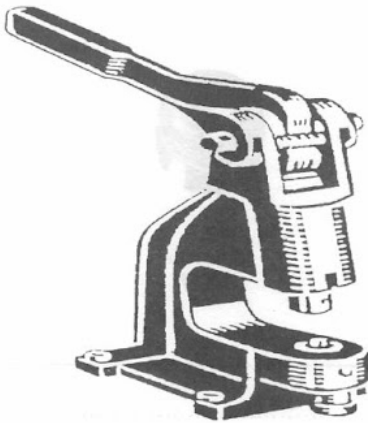

Button Machine Dies for Durable Fasteners  
 Special Order 4 pc. Set for Deviance or Handy  
 Button Machine

**Call for Price**

**FASTENERS-TOOL CROSS REFERENCE LIST**

**DURABLE FASTENERS:**

Part No.	Hand Tool NUMBER	Machine Tool Number
X2-10128	9937	1401
X2-10127	9937	1401
XB-10124	164	1410
BS-10370	164	1412
XB-10704	169N	-----
XB-10708	169N	-----
XB-10393	169N	-----
BS-10412	9936	1407
BS-10413	9936	1407

**COMMON SENSE FASTENERS**

Part No.	Hand tool Number	Machine Tool Number
XB-78322	----	----
XB-78323	----	----
XB-78324	9908	----
XX-78325	9908	----
XB-78332	171	----
BS-78507	----	----
BS-78403	450	----
BS-78505	----	----

**LIFT-A-DOT FASTENERS;**

Part No.	Hand Tool Number	MachineTool Number
XX-16205	9951	1454
XX-16206	9951	1454
BS-16506	----	1455
BS-16349	171	8043
BS-16501	----	8042
XB-16358	9940	1456
BS-16509	9941	1457
XB-16317	169B	----
BS-16318	169B	----
XX-16362	169B	----

**THE GF LINE FOR PRESS N SNAP AND OTHER FASTENER TOOLS TOLL FREE 1-800-237-667**

**PRESS-N-SNAP TOOLS**

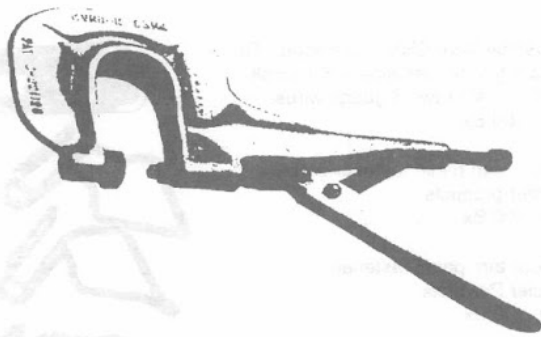

Install snaps and grommets quickly.

**Pres-N-Snap Tool Kit** comes with Snap Dies and #1 Grommet Dies.

**Replacement parts include:** Bolt and Nut, Frame, handle, Lever, Plunger (Shaft), Rubber Ring for dies, and Spring  
**ORDER**

- PNS Press & Snap Tool Kit.....
- PNS Durable Die (24 line- regular)....4 pc. set.
- PNS X2-10128.....
- PNS BS-10370.....
- PNS BS-10412.....
- PNS M2700 Rubber Rings for Dies.....
- PNS Frame only.....
- PNS Handle only.....
- PNS Plunger (Shaft).....
- PNS Lever only.....
- PNS Spring only.....
- PNS XB-10224 Socket Adapter.....
- PNS Baby Durable Dies(20 Line.....4 pc. Set...
- PNS Bolt & Nut.....
- PNS O Ring small.....
- PNS Stud Ring "O".....

**HOOVER PRODUCTS (BENCH DIES)**

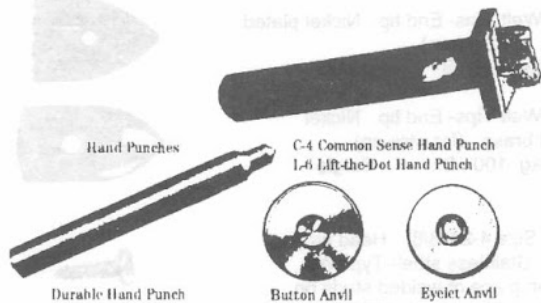

**ORDER**

- C-4 Common Sense Punch.....
- L-6 Lift-the-Dot.....
- Durable Punch Hand.....
- Eyelet Anvil.....
- Button Anvil.....
- PNS 0 Grommet Die.....
- PNS 1 Grommet Die.....
- PNS 2 Grommet Die.....
- PNS 1 Spur Grommet Die.....

**ZENDA LEATHER CARE KIT**

Zenda cleans, protects & conditions leather to maintain and restore the natural beauty of leather. Can be used on all types of leather (except Nubuck leather) and for different applications, aircraft, automotive, furniture, marine, etc.

Zenda kit comes with 8oz bottle of cleaner and 8 oz bottle of conditioner and 2 cleaning cloths.





**2288-** Door inside handle retaining clip; door and quarter regulator handle retaining clip: All General Motors cars, Ford and Mercury cars. Unit pkg. 100 Bx.....



**8941-** (C5ZZ-654313-B)-Rear window reveal molding fastener: Ford'66-'80 Windshield reveal molding fastener: Ford 66-80 Galaxie, Fairlane, Falcon, Mustang and T-Bird. Unit pkg. 100 Bx.....



**7530-** Plain Steel 1/2"x 1/2". Use ordinary pliers for closing clip. Unit pkg. 100 Bx.....

**PANEL & CARPET FASTENERS**



**1117-** Brown, Japan, General Purpose: All cars all models. Unit pkg. 100 Bx.....



**1202-** Brown. General Purpose: All cars all models. Unit pkg. 100 Bx.....



**12134-** (4114786)- Zinc. Trim Panel Fastener. Chrysler Prod. 79-80. Unit pkg. 50 Bx.....



**10621-** (2064891) (9883583)- Nylon. Door Trim Pad to inner panel fastener. All GM cars '71 -fastener. All GM cars' 71 -'85. GM trucks 81 -85. Unit pkg. 50 Bx.....



**11678-** Chrysler (6003349), GM (9685057). Nylon. Head size 15/16". Length 7/8". Christmas Tree" Interior door trim panel fastener. Chrysler products: '76-'85. General Motors: '76-'85. J Body S-10-S-1 5 Truck. Unit pkg. 25 Bx.....



**V23103** Carpet Fasteners- Clinch type socket is attached to the carpet, (by a prolonged ring). Which won't pull through the carpet, when it is snapped off the stud. The ring and socket are finished in antique black. Unit pkg. 100 Pcs. Combination Box ..... **SINGLE**



**7706-**Cushion Wire Clips- Cloth lined. To wire spring to border wire-7/8" overall Length. For 1/8" or two 10 gauge wires. Unit pkg. 100 Bx. ....**DISC**



**2309** Door Trim Fastener- (Ford, Mercury) All cars with .125 panels. Unit pkg. 100 Bx.....

**7707-**Cushion Wire Clips-Cloth lined. To fasten spring to border wire- 7/8" overall length. For 1/4" or two 8 gauge wires. Unit pkg. 100 Bx.....

**2310-** Door trim panel fastener bottom: All Chrysler products. Unit pkg. 100 Bx.....

**2385-** Door trim panel fastener. All Chrysler Products. Unit pkg. 100 Bx.....

**10780** (383033-S1O1)- Door trim panel fastener Ford. Unit pkg. 100 Bx.....

**15479** (N804349S)Black Nylon Interior Trim Retainer Ford 1986-ON Package 25.....

**9416-** Panel range .060-090. General purpose All cars, all models. Unit pkg. 100 Bx.....

**9417-** Panel range .105-.115. General purpose: All cars, all models. Unit pkg. 100 Bx.....

**15414** (GM:1605396-Chry-6030441 Ford388577S) Black Nylon Radiator Yoke, Fender & bumper Shield Retainer Unit Package 100.....

**9367** (4495047)-Arm support (front seat). Hinge pin retainer: GM products Unit pkg. 100 Bx.....

**2850-** Front seat self locking fastener. (Ford) Unit pkg. 100 Bx.....

**7181** Welt Tips- End tip. Nickel plated brass. (for hydrem) Unit pkg. 100. Bx. Single

**7185-**Welt Tips- End tip. Nickel plated brass. (for wire-on) Unit pkg. 100...Bx. Single

**9877-** Size 4-24x3/8". Head size 7/32". Stainless steel- Type AB. Used in place of welded studs on Landau Tops. Use w/AUVECO. No hole molding fasteners. All cars. Unit pkg. 100 Bx.....

**808** General Purpose Chrysler Unit package 100.....

**V15098** Double ended Christmas tree Fastener with inner stop Unit pkg 100 Bx .....



**THE GF LINE FOR YOUR AUEVCO PRODUCTS-TOLL FREE 800-237-6677**



**12069** (416629)- Zinc. Upholstery (Clips. GM cars 1979-80. Unit pkg. 50 ..... Bx.



**12670**- replaces 7701- 7/16" nail (.460). "Nail on" door panel repair clip. All General Motors. To be slipped on door panel fastener strip for repairs to replace broken nails in panel edging. Unit pkg. 50 ..... Bx



**12671** - replaces 7585- 3/4" nail (.750). "Nail on" door panel repair clips. Chevrolet and Fisher bodies. To be slipped on door panel fastener strip for repairs. To replace broken nails in panel edging. Unit pkg. 50 ..... Bx.

**V15098** Double ended xmas tree fastener  
Unit pkg 100 .....Bx



**9317**- Pan'l High Speed twist 135 degree split point. Decimal size .1285, Fractional equivalent- 1/8", Unit pkg.-12 .....Bx.



**NOT AVAILABLE**



**NOT AVAILABLE**



**SPONGE RUBBER WEATHER-STRIPS**  
Black closed cell, Light weight weather resistant.

**Sponge Rubber Windlace Cord-**  
Resilient and flexible. (4655 illustrated). Flexible filler for cloth covered windlace on door and windshield pillars and door bottoms. Unit Package 50 ft.

**4655** (3/8" diameter) .....Bx.

**4656** (1/2" diameter)..... Bx.

**4675**- Door flange weather-strip: All General Motors cars. All

Chrysler products, Ford, Lincoln, Mercury. Also truck and truck cabs. Unit pkg. 50 ft.....Bx.

**SCREWS**

Slotted round head machine screws- Bright zinc chromate. Auveco part  
**8031** Size 1/4" - 20x1" 100 Bx  
**8033** Size 1/4" - 20x1-1/2" 100 Bx



**POP ON SCREW COVERS & BASES**

**Covers-**

**Auveco Part No. 13837**, Screw size. #10, Black  
Unit Pkg. 50 .....Bx.

**Auveco Part No. 13838**, Screw size #10, White  
Unit Pkg. 50 .....Bx.



**Bases-**

**Auveco Part No. 13842**, Screw size #10, Use with cover # 13837, 13838 & 15220,  
Unit Pkg. 50.....Bx.



**Phillips Oval Head Tapping Screws**



**ORDER Auveco**

Part No.	Size	Finish	Pkg.	Price
<b>3068</b>	4 x 1/2"	Chrome	100	
<b>3069</b>	4 x 3/4"	Chrome	100	
<b>3070</b>	4 x 1"	Chrome	100	
<b>2698</b>	6 x 1/2"	Chrome	100	
<b>1793</b>	6 x 5/8"	Chrome	100	
<b>1794</b>	6 x 3/4"	Chrome	100	
<b>1796</b>	6 x 1"	Chrome	100	
<b>1797</b>	6 x 1 1/4"	Chrome	100	
<b>2027</b>	6HD 8 x 1/2"	Chrome	100	
<b>2707</b>	8 x 1/2"	Chrome	100	
<b>2709</b>	8 x 5/8"	Chrome	100	
<b>1799</b>	6HD 8 x 3/4"	Chrome	100	
<b>1421</b>	6HD 8 X 5/8"	Chrome	100	
<b>2710</b>	8 x 3/4"	Chrome	100	
<b>1483</b>	8 x 1"	Chrome	100	
<b>2713</b>	8 x 1"	Chrome	100	
<b>2715</b>	8 x 1 1/8"	Chrome	100	
<b>2716</b>	8 x 1 1/4"	Chrome	100	
<b>2717</b>	6HD 8 x 1 1/2"	Chrome	100	
<b>2718</b>	8 x 1 1/2"	Chrome	100	
<b>2633</b>	8 x 2"	Brz. Zinc	100	
<b>2728</b>	10 x 3/4"	Chrome	100	
<b>2730</b>	8HD 10 x 1"	Chrome	100	
<b>2735</b>	10 x 1 1/4"	Chrome	100	



**Auveco Phillips Oval Head Machine Screws**

<b>1413</b>	10/32 x 1"	Chrome	100
<b>1863</b>	6HD 8/32 x 3/4"	Chrome	100



**Phillips Oval Head  
Tapping Screws-**

hardened- 300 series  
**ORDER Auveco Part  
No. 9404, Size 8 x 3/4",  
Unit Pkg. 100.....Stainless Steel.....Bx.**

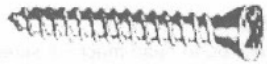

**Phillips Oval Washer Head  
Tapping Screws- Sems**

Chrome Plated  
**ORDER Auveco**

Part No.	Size	Finish	Pkg.	Price
3537	6 x 5/8"	Countersunk	100	
3538	6 x 3/4"	Countersunk	100	
2771	8 x 5/8"	Countersunk	100	
2751	8 x 3/4"	Countersunk	100	
2772	8 x 1"	Countersunk	100	
2773	8 x 1 1/4"	Countersunk	100	



**BLACK OXIDE PHILLIPS HEAD  
WITH WASHERS TEKS SCREW.**

8 x 1 1/2" 7/16" washer head O.D.  
GM & Ford. Unit package 50 ea.



**ORDER AUVECO 15774.....**

**Phillips Oval Washer Head  
Tapping Screws-Sems**

Black Phosphate Finish,  
countersunk

**ORDER Auveco 11788, Size  
8 x 3/4". Unit Pkg. 100.....**

**ORDER Auveco 11789, Size 8X1".  
Unit Pkg. 100.....**



**WASHERS**

Countersunk Type- Nickel plated on brass.

ORDER Auveco Part No	Price 100	ORDER Auveco Part No	Screw Size	Price 1000
612	4.82	7613	No. 4	
614	5.23	7615	No. 6	
		7616	No. 8	
618	6.77	7618	No. 10	

**Flanged Type Countersunk Washer-**

Auveco  
Unit

Part No.	Size	Finish	Pkg.	Price
3469	No.6	Nick/Brass	100	
2515	No.8	Nick/Brass	100	

**AUVECO 11324 1/4" T-Nuts (50 Per Box)**



**ORDER Flush Type**

Auveco  
**Part No. Price 100**  
602- No 6 washer  
604- No 8 washer



**NUTS**

**ORDER Auveco 1898- No. 6/32 Screw  
size. Unit Pkg. 100.....Bx**

**ORDER Auveco 1899- No. 8/32 Screw size,  
Unit Pkg 100.....Bx.**

**ORDER Auveco 2099- 1/8" Stud size,  
Unit Pkg, 100.....Bx.**

**FLAT PUSH-ON RETAINERS**

Zinc Plated

**ORDER Auveco 8863, Size 1/8"  
Unit Pkg 100.....Bx.**

**ORDER Auveco 10375, Size 1/2"  
Unit Pkg 100..... \*\*DISC\*\***

**HEXAGON MACHINE SCREW NUTS**

Double (chambered- plain brass)..

**ORDER Auveco 3869, Size 10-32 SAE,  
Hexagon width 3/8",  
Unit Pkg. 100.....Bx.**



**PLATFORM, ROCKER SPRINGS**

8 Gauge Metal.

Per Pair.....  
Per case (20 Pair)

**ORDER No. Rocker Springs**

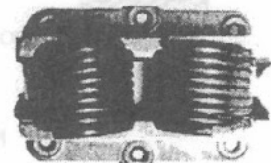

**NO-SAG SPRINGS**

These springs are engineered and precision formed to assure a lifetime of trouble-free performance. Made of high carbon, high tensile steel, when uncoiled stretched and anchored, the arc of sinuous spring wire provides wide-span progressive resilience and positive comfort.

**ORDER No Sag 9 ga. for seats (120 ft. roll).....**

**ORDER No Sag 11 ga. for backs (140 ft. roll)...**  
Less 10% on 10 roll purchase.

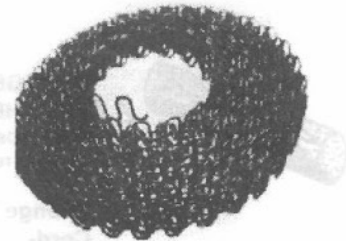

**"E" CLIPS-Used with nails. Insulated**

Per 100.....  
Per 1000 .....

**ORDER E Clip**





**SPRING BENDER-#401**



Chrome plated ends are slotted to fit loops which can be bent with slight hand pressure or can be used to unbend previously made bends.

**ORDER 401 1" Loop Bender**  
(Pr.)Osborne.....

**SPRINGS AND CLIPS**

Knotted one end. 6" coil (10 gauge)- 4 springs per lb.  
7" coil (10 gauge)- 3 springs per lb.  
8" coil (10 gauge)-3 springs per lb.  
9 1/2" coil (10 gauge)-2 springs per lb.  
10 1/2" coil (9 gauge)-2 springs per lb.  
12" coil (9 gauge)-3 springs per 2 lbs .  
Per lb.....  
Per lb. in bundle (Prox. 55 lbs.).....

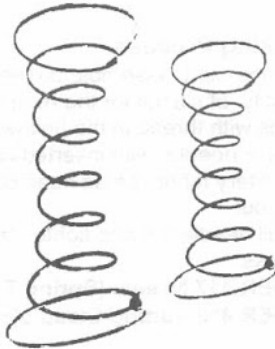

**ORDER COIL and SIZE**

**Flanged Clip-3 Pronged**  
Per 100 (pkg)  
**Flanged Clip-5 Pronged**  
Per lb

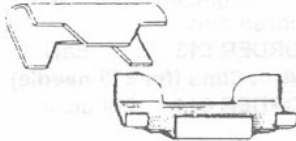

**ORDER 3 or 5 Prong Clip**

**SPRINGS EDGEWIRE**

Made of high carbon spring steel, 9 gauge, 10 ft. lengths.

**ORDER EDGEWIRE**

Per lb. ....



**#1963 WIRE FORMER** Tool  
**ORDER 1963** Each



**CUSHION UNITS**

Marshall cushion units are hog-ringed, muslin covered. 3" wide x 3 1/2" high- 15 gauge. 7 x 7 (15 ga.) 21" x 21"

**ORDER CUSHION UNIT**

Each.....

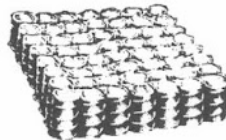

**TORSION SPRINGS**

Ideal for use in supporting edgewire on T-shaped frames.

**ORDER TORSION SPRINGS**

Ea. ....  
Per 100 .....



**WEBBING**

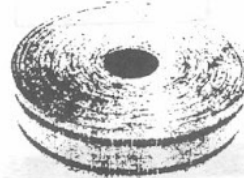

**Jute- 11 lb. 3-1/2" wide**

**ORDER JUTE 11**

Per yd.....  
Per roll (72 yds).....  
Per roll (@ 6 rolls)...

**ELAS-A-BELT Webbing- 2" wide-**

**ORDER ELAS WEB**

Per foot (cut).....

Per roll (164 ft.).....

Less 10% of roll price per case of 4 rolls

**Clips for ELAS-A-BELT Rubber Webbing-**

**ORDER V Clip**

Each.....

Per 100 clips.....

Per box of 1250 clips.....

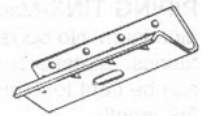

**2" Nylon Belt Webbing -ORDER Nylon 2 Black**

Per yd. cuts.....

Per yd. (50 yd. roll).....

**WEBBING STRETCHERS**

**#255-Rubber end-Hardwood** with polished steel pins. Has rubber on butt end.

**ORDER 255.....**



**#253 Gooseneck Webbing Stretcher**

Gives greater leverage, protects against injury on pins, frees both hands. Has rubber on butt end, hardwood handle and polished steel pins.

**ORDER 253.....**



**#258-Metal Webbing Stretcher**

(4 in one tool)-Four stretchers in one for all types of metal webbing. Has "beavertail" handle to lean against.

**ORDER 258.....**



**#250-Webbing Pliers-**

For webbing and all materials. Features bulldog grip, special prying fulcrum.

**ORDER 250- 3 1/2 (Wide) Jaw.....**

**ORDER 251- 1 1/2 (Narrow) Jaw.....**



**THE GF LINE FOR ALL YOUR UPHOLSTERY NEEDS-TOLL FREE 1-800-237-6677**

**CHALK**

Hygieia (hard) chalk



**ORDER Hygieia-**

.....Per box (144 pcs)

**ORDER Chalk Pack (Hygieia only).....Pkg (12 pcs)**

**RAZOR BLADES-Single edge.**

**ORDER Blades**

Per 100.....

5 Boxes each.....

10 Boxes each.....

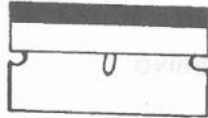

**PIN REMOVER AND RESETTER**

**#96-**Removes and resets. For use with LaZ-Boy, permits easy access to retaining key pin. One shot in and out. No frantic spinning to find proper hole.

**ORDER 96** .....

**PIPING TINS-**Made of smooth aluminum. No burrs to catch on fabrics. Material is soft so tins can be bent to different sizes. 36" length.

**ORDER 412 2"-** .....(2)

**ORDER 412 3"-** .....(2)

**ORDER 412 4"-** .....(2)



**PLIERS**

**#445-Spring Clip Pliers**

A special pair for setting spring or edgewire clips.

Great time saver

**ORDER 445.....**

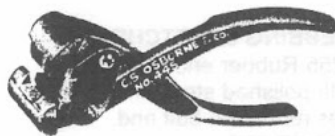

Osborne No. 445

**#414 Mattress Button Tufter-**

12"-11 gauge Knob on End Tufter.

**ORDER 414** .....Each

**Mattress Button Tufter**

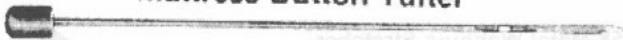

**Timesaver Tufting Needle-**

A new type of tufting needle.

Inserts buttons without the necessity of removing cover.

A real time saver!

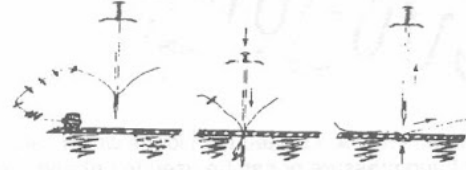

**Working Process:**

1) At the start, assemble on the thread the corresponding quantity of clasps for the required number of stitches. Insert clasps with thread in the hollow of the needle.

2) Push needle (with inserted clasp and thread) through upholstery fabric, press head of needle. Clasp with thread will jump out.

3) Pull needle out and tighten thread. Repeat working process.

**ORDER 417 Needle (Spring Type)..... Each**

**ORDER 418 Tufting Clasp 500..... Each**

**NEEDLES-TUFTING**

**#613 Tufting Needle Kit-**

12"-10 gauge. Packed with 2 dozen clips.

**ORDER 613..... Each**

**#614 Clips (for 613 needle)**

**ORDER 614.....Per gross**



Tufting Needle

**THE GF LINE FOR NEEDLES AND PINS-TOLL FREE 1-800-237-6677**

**T" PINS**

Sold in 1/2 boxes. 1 1/2" length.  
**ORDER 189-24**.....  
 (Less 10% on 5 lbs. or more)



**TWIST PINS #81085**

100 Per Box  
**ORDER Twist Pins**.....



**UPHOLSTERERS PINS**

#190- 3", 16 gauge,  
 3"- ..... 16 Ga.- 1/4 Gross.....Gross  
 3 1/2"- ..... 16 Ga.- 1/4 Gross .....Gross  
**ORDER 190-3 or 190-3 1/2**



**NEEDLES**

**Straight Single Round Point-**



#504- 10"- 13 Gauge-.....Each .....Dozen  
 #504- 12"- 13 Gauge-.....Each .....Dozen  
 #504- 16"- 12 Gauge-.....Each .....Dozen  
 #504- 18"- 12 Gauge-.....Each .....Dozen  
**Order 504 and Needle Size (10" etc.)**

**Straight Double Round Point-**

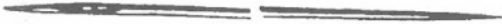

#555- 10"- 12 Gauge-.....Each .....Dozen  
 #555- 12"- 12 Gauge-.....Each .....Dozen  
 #555- 16"- 11 Gauge-.....Each .....Dozen  
 #555- 18"- 11 Gauge-.....Each .....Dozen  
**ORDER No. 555 and Needle Size (10" etc.)**

**Straight Single 3 Square Point-**



#556- 10"- 12 Gauge-.....Each .....Dozen  
 #556- 12"- 12 Gauge-.....Each .....Dozen  
 #556- 14"- 12 Gauge-.....Each .....Dozen  
 #556- 16"- 11 Gauge-.....Each .....Dozen  
 #556- 18"- 11 Gauge-.....Each .....Dozen  
**ORDER 556 and Needle Size (10" etc.)**

**Straight Double 3 Square Point-**



#914- 10"- 11 Gauge-.....Each .....Dozen  
 #914- 12"- 11 Gauge-.....Each .....Dozen  
 #557- 14"- 12 Gauge-.....Each .....Dozen  
 #557- 16"- 11 Gauge-.....Each .....Dozen  
 #557- 18"- 11 Gauge-.....Each .....Dozen  
**ORDER 914 or 557 and Needle Size (10" etc.)**

**Flocking or Roll Edge-**



#514- 7"- 11 Gauge- .....Each .....Dozen  
 #514- 8"- 11 Gauge-.....Each .....Dozen  
**ORDER Flocking and Size (7" etc.)**

**Upholsterers Regulator with Eye-All Steel**



**ORDER 9026 or 926**  
 #9026(10 Ga.) & 926(8 Ga.)-10"- .....each.....



**Upholsterers Regulator with Plastic Handle-**  
 #520- 12"- 9 Gauge  
**ORDER 520 12" Regulator**.....Ea.

**Curved Round Point-**

#501X 2"- 21 Gauge-..... Each .....Dozen  
 #501-2 1/2"- 18 Gauge-..... Each .....Dozen  
 #501-3"- 18 Gauge-..... Each .....Dozen  
 #501X-4"-18 Gauge-..... Each .....Dozen  
 #501-5"- 16 Gauge-..... Each .....Dozen  
 #501-6"- 15 Gauge-..... Each .....Dozen  
 #501-8"-13 Gauge-..... Each .....Dozen

**Curved 3 Square Point-**

#502-2 1/2"- 18 Gauge-.....Each .....Dozen  
 #502-3"- 18 Gauge-.....Each .....Dozen  
 #502X-4"- 18 Gauge-.....Each .....Dozen  
 #502-5"- 16 Gauge-.....Each .....Dozen  
 #501-6"- 15 Gauge-.....Each .....Dozen

**K-3 & 4 Card**

Assortment composed of four curved round point needles-3", 4", 5" and 6"  
**ORDER** .....

**K-3 Card**

Assortment composed of four curved 3 square point needles-3", 4", 5" and 6".  
**ORDER K4 Card**.....

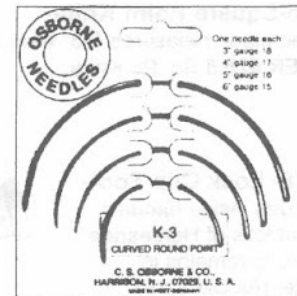

**NEEDLES-SEWING**

**MACHINES \*\*ORDER # & SIZE\*\***

Machine	Size	No.	Pkg. of 10	Pkg. of 100
Pfaff 145 H3	140, 150, 160	134-35		
Pfaff 145 H4	140, 150, 160	190R		
16 Class Singer	18, 22	16 x 63		
31-15-19 Singer	18, 22	16 x 87		
78 Class Singer	22	16 x 99		
111W Singer	18, 22, 23	135 x 17		
31:15 Singer Dbl. Welt Foot 3/16"				

Other sizes available upon request. \*Pfaff #545 Use 190R Needles.

**ORDER WELT FOOT** .....

**TUCKING TOOL**



For tucking headlining and upholstery around windows and above doors or other hard to reach places. A sturdy tough tool with a slightly curved blade that has finished edges and rounded corners. Has a wooden handle.

**ORDER 746** Flexible.....  
**ORDER 747** Rigid.....

**TRIMMERS AND UPHOLSTERERS COMBO KNIFE**

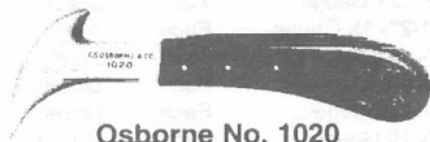

**Osborne No. 1020**

Used for ripping seams. Cuts auto carpeting, vinyl, plastic and rubber. Beechwood handle contoured to fit the hand. A handy professional tool.

**ORDER 1020** Combo Knife.....



**#76.5-Square Point Knife-**

Pinned blade measures 5/8" wide by 3 7/8" long .

**ORDER #76.5** Sq. Pt. Knife.....

**#7778- Lock Clip Tool-**

Removes inside handles without loss of Horseshoe Clip. Clip remains in handle. (All GM cars). Actual size 6 1/4".

**ORDER Auveco 7778**.....



**#7999- Trim Pad Removing Tool-**

The first tool designed specifically to pull out the plastic trim pad fasteners used on GM cars. It reaches under the trim panel, supports and grips the plastic fastener, and lifts it without damage to the fastener or to the trim pad backboard. Made of heat treated, high carbon steel and will work equally well on metal fasteners.

**ORDER AUVECO 7999** .....



(Not Actual Size)

**#7672- Headliner Tool-**

Stuffs headliner in channel above doors. Stuffs upholstery, trim edges into tedious places. Blunt edge of blade cannot damage material. Easy to use around curves and near corners.

**ORDER Auveco 7672**.....



**TYPAR SEAT LISTING TAPE**

1-1/2" Black folded and stitched (with cord)

Sold in 100 yard rolls

**ORDER SEAT LISTING**.....

**SEAT COVER SOFT VELCRO**

1-1/2 White with red stripe

Sold in 25 yard rolls

**ORDER SEAT COVER VEL**

**THE GF LINE FOR YOUR HEADREST REMOVING AND TRIM TOOLS TOLL FREE 800-237-6677**

**AUTOMOTIVE TOOLS**

**#184 Headrest Lock Release Tool-**  
Depresses spring lock mechanism on Ford products for easy removal of permanent headrests. Instructions included.  
**ORDER #184** .....



**#185 Headrest Lock Release Tool-Set of tools releases**  
spring lock mechanisms on double post headrest found on Chrysler, Dodge and Plymouth products.  
**ORDER #185**.....

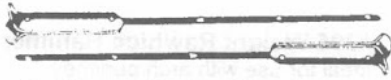

**#752 Headrest Release Keys-** Available in 1/4", 5/16", 11/2" 3/4" width, packed individually or in sets

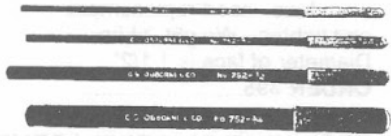

**ORDER 752 and Size (Individually)**.....  
**ORDER K752 (4 Pc. Set) Ford**.....

**#753 Use on GM cars through 1977**  
**ORDER 753**.....



**#754- Use on Ford cars**  
**ORDER 754** .....



**#755-Use on large body 1977 GM products**  
**ORDER 755**.....



**#15301 Clip Removal Tool-**  
The right tool for removing clip and retainers quickly and easily. Simply seat the tool on the shaft of the fastener and squeeze the handles together. Made of high carbon steel and heat treated for strength. Zinc plated with vinyl molded handle grips.  
**ORDER Auveco 15301**.....



**CUSHION SEAM STRETCHER**  
**#267-Made of lightweight aluminum.**  
Simple toggle clamp construction. Easy to operate. Minimum length 12" maximum length 3 Ft. Rigid when in use, no springs or chains.  
**ORDER 267**.....



**#214 Groove Tool-Ideal for removing staples recessed in grooves.**  
**ORDER 214**.....

**RIPPING CHISEL**  
**#402-Ripping Tool**  
Translucent amber handle beautifully finished, designed to fit the hand with perfect balance. Forged, highly polished steel blade.  
**ORDER 402**.....



**CLIP TOOLS**  
**#97 Moulding Clip Tool-**Installs and removes the plastic clips which hold moulding strips. Just press down and slide clip on or off.  
**ORDER 97**....\*FACTORY DISC\*.....



**#99 Retainer Clip Installer-**Places trim retainer clips over headed studs welded around the body window shields and rear window openings.  
**ORDER 99**.....\*FACTORY DISC\*.....



**Berry's Staple Remover**  
**ORDER Berry Puller**.....

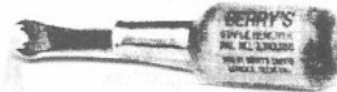

**Osborne 120- Staple Knocker-** These tools will lift fancy nails or tacks all the way out, no heel needed. Manufactured from top grade steel. Electronically hardened working ends. Easy to grip handle. Used with Osborne hickory or rawhide mallets. Weight per each 4 oz.  
**ORDER 120**.....



**#121- Tack and Staple Remover-**Overall length is 6 1/2". Made of forged steel with a wooden handle.  
**ORDER 121**.....



**#402.5- Ripping Tool / Tack Puller-**Combined ripping tool and tack puller. Amber plastic handle. Polished blade.  
**ORDER 402.5**.....



**#200- Claw Tool-** Narrow at the point to get under heads of ornamental nails and tacks without harming fabric or wood. A popular upholsterer's tool.  
**ORDER 200** .....



**NAIL, STAPLE AND TACK REMOVERS**

**#601- Fancy Nail Lifter-**



This tool makes removing antique and fancy nails easier. Has opening spring.

**ORDER 601**.....

**HAMMERS**

**#36- Bronze Magnetic Hammer**

This hammer has large face that is fitted with a nylon tip. Prevents damage to ornamental nails. Small face is magnetic. Head weight is 7 oz.

**ORDER 36**.....

**ORDER 36T Nylon Tip for #36**..



**#277.5- Ripping**

**Hammer-**Forged tool steel. Double edged for stripping off old fabric. Length of head 5". Length of bit 1 3/16". Weight is 10 oz.

**ORDER 277.5**.....

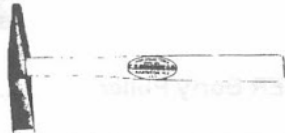

**#222 Hammer Handles-**

**ORDER 222 H**.....

**#33 Bronze Magnetic Hammer-**

Solid head of bronze. Steel tipped at one end for permanent alnico magnet: at the other for hammering. Length of head-5 1/2". Weight 17 oz.

**ORDER 33**.....

**#238 Split head Magnetic Hammer-**

Open slot. Tough and well balanced. Head weight is 8 oz.

**ORDER 238**.....



**MALLETS**

**#89.5 Hickory Mallet (Large)**

Tough kiln-dried hardwood. Has 16 oz. head. Measures 5 3/4" x 2 3/8".

**ORDER**

**89.5 Large Mallet**.....



**#89.5 Hickory Mallet (Small)**

Has 12 oz. head. Measures 5" x 2".

**ORDER**

**89.5 Small Mallet**.....

**#196 Rawhide Mallet-**

Rolled from tough water buffalo hides, fastened securely to seasoned hickory handles. Lead within folds of rawhide give lead-weighted mallets greater striking force without sacrificing resilience of rawhide faces. Measures 2" x 3 1/2".

**ORDER 196**.....



**#395 Weight Rawhide Hammer (Split head)**

Ideal for use with arch punches, grommet dies and wherever a cushioned blow is desired. No trouble to replace faces-just loosen the safety nut, remove worn face, insert replacement and tighten. Weight-2 Lbs. Diameter of face is 1 1/2".

**ORDER 395**.....

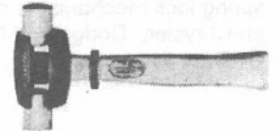

**EDDY HEAT GUN REPLACEMENT PARTS**

This heat gun is discontinued but we still have inventory on these replacement Parts.



**ORDER**

**1055** Heat Element 750 degree.....

**1A502** Heat Element 500 degree.....

**1A503** Heat Element 750 degree Master.....

**1A504** Heat Element 1000 degrees Master.....

**WAGNER HT1000 HEAT GUN-** Dual temperature settings

Setting1 (750 degrees) Setting 2 (1000 degrees)

**ORDER HT1000**

- Quality heat element
- Solid state construction
- Strip paint and varnish
- Thawing or Drying
- Shrinking or softening
- 2 speed motor

**ZS OIL ZOOM SEWING MACHINE OIL**

4oz bottle w/ zoom spout.

**ORDER ZS OIL**

**REPUBLIC HOG RING PLIERS**

Professional craftsmen tool with internal spring system to hold

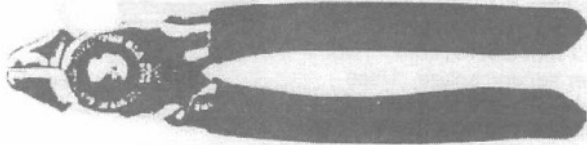

the tool closed with the ring in position ready for installation.

**ORDER XX PLIER** (Red Handle).....

Upward angled nose design allows for easy access into

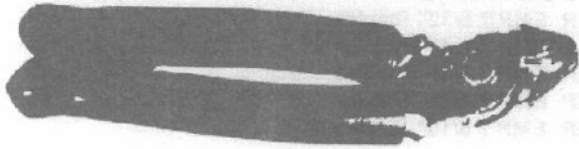

corners and work areas near flush surfaces. An internal spring system holds the spring closed.

**ORDER XXL PLIER** (Red Handle).....

**OSBORNE HOG RING PLIERS**

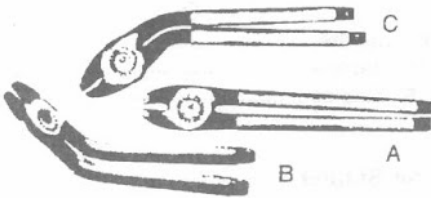

**Osborne No. 1440**

Straight handles, 6 3/4" long, has closing spring

**ORDER 1440AC**.....

Handles are bent at 135 degrees angle to saw. Has closing spring.

**ORDER 1440BC**.....

Handles are bent to reach difficult spots. Jaws and handles are aligned. Has closing spring.

**ORDER 1440CC** .....

**HOG RINGS**

To attach seat covers to cushions and seat bottoms. Polished 3/4". Available by the pound.



OPEN



CLOSED

**ARROW STAPLES & TACKERS**

**P-22 Heavy Duty Plier-Type Stapler**- Hand held for greater maneuverability. Designed for reaching into hard to get at places for stapling from any position or angle. Staples packed 5M.

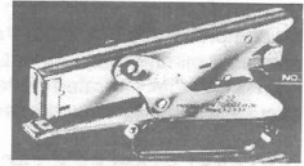

**ORDER P-22 Stapler** .....

**ORDER P-22- 1/4" Staples** ..... (5000)

**ORDER P-22-5/16" Staples** .....(5000)

**BOSTITCH STAPLES & TACKERS**

**P3 Stapling Plier**- Light and powerful to do a full-size job. Convenient top loading- just pull pusher back and drop staples in.



**ORDER P3 Staple Plier** . 27.50

**ORDER No.SP-19 1/4"**

Staples .....(5000) .....

**AIR TOOL ACCESSORIES**

**Pneumatic Air Tool Oil-Quart**

**ORDER TT8**.....

**ID Curled Air Hose**

25 ft., 1/4"

**ORDER 2Z253**.....



**Air Hose Pig Tails 12"**

**ORDER Pig Tail**.....



**1X919-Quick Change Coupler 1/4"**

**ORDER Pig Tail 1x919**.....



**2X169-Male Plug**

**ORDER Pig Tail 2X169**.....



**2X170-Female Plug**

**ORDER Pig Tail 2X170**.....



**ELECTRIC STAPLERS**

Electric Tackers- provide high production tacking where no air compressor is available. Very fast-drives up to 300 staples a minute. Self lubricating- needs no oil. Does not heat up, trigger operated. Extended front nose affords accuracy in positioning staples.

**DUO-FAST STAPLES & TACKERS**

CT-830 Standard Model Gun Tacker AND EWB 3012 ELECTRIC TACKER HAVE BEEN DISCONTINUED. The following are the only staples still available.

- ORDER 308- 1/4" Staples.....(5000) .....
- ORDER 3012- 3/8" Staples.....(5000) .....

**EIC 5018 ELECTRIC AND CT-859 Heavy Duty Hand Tacker** -Used when longer, heavier staples are needed. Drives heavy, wide crown staples. **Call for Pricing**  
**EIC 5018** .....(Special Order).....  
**CT-859 Stapler** .....(Special Order).....  
 Less 10% on 20 box case-5000 Staples per box

**Galvanized Staples**

- ORDER 508- 1/4" Staples.....
- ORDER 5010- 5/16" Staples.....
- ORDER 5012- 3/8" Staples.....
- ORDER 5016- 1/2" Staples.....

**ENC-5018- Stapler-** Drives heavy wire, narrow crown staples. ....**Special Order...Call for Pricing**  
**ORDER 5412 3/8" Staples**.....(5000)....

**EIC 3118-Electric Stapler-**Drives medium wire, intermediate crown staples.....**Special Order...Call for Pricing**  
**ORDER 3108 1/4" Staples**.....(23,380).....  
**ORDER 3112 3/8" Staples**.....(16,700).....  
**ORDER 3116 1/2" Staples**.....(13,360).....  
**ORDER 3118 9/16" Staples**.....(13,360).....

**DUO-FAST SPECIAL STAPLES "D POINT" "C POINT" Stainless Steel**

- ORDER 508-1/4" (5000) .....
- ORDER 5012- 3/8" (5000) .....
- ORDER 5016- 1/2" (5000) .....

**Empire Electric Stapler**

The lightest professional tool on the market. 110-120 V AC 50-60 hz. Quick Clear staple nose. 3 wire, 12 foot electric cord. Two shot per second speed. Uses regular #7 Empire staples. **NOT RECOMMENDED FOR HEAVY USE**

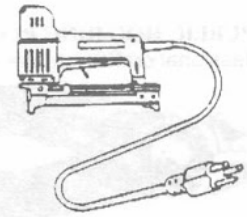

**Order EMP 7 ELECTRIC** .....

- 7 Intermediate Crown Staples-10,000 Per Box** (BEA Brand Staples)
- ORDER EMP 7 5/32" Staples**.....
- ORDER EMP 7 1/4" Staples**.....
- ORDER EMP 7 3/8" Staples**.....
- ORDER EMP 7 1/2" Staples**.....
- ORDER EMP 7 9/16" Staples**.....

- Stainless Steel Staples-10,000 Per Box**
- ORDER EMP 7 1/4" SS Staples**.....
- ORDER EMP 7 3/8" SS Staples**.....
- ORDER EMP 7 1/2" SS Staples**.....

**Empire Air Stapler- Narrow Crown** .....

**ORDER EMP 9 (Special Order)**

- ORDER EMP 9 3/8" Staples**.....
- ORDER EMP 9 1/2" Staples**.....
- ORDER EMP 9 9/16" Staples**.....

**LU 7116 Apach Air Stapler**

Uses #7 Staples  
**ORDER LU 7116**.....

**LU 7116 Long Nose Apach Air Stapler**

Long nose (2") uses #7 Staples  
**ORDER LU 7116LN**.....

- Stainless Steel Staples – 10,000 Per Box**
- ORDER 71 1/4" SS Staples**.....
- ORDER 71 3/8" SS Staples**.....
- ORDER 71 1/2" SS Staples**.....





**REPAIR KITS for EMPIRE STAPLERS**

Model 7 Complete Kit...(Emp kit).....  
 Model RIA7C-16 Complete Kit... (Emp kit new).....

**BEA AIR STAPLE GUN**

One of the best known and highest Quality air guns on the market today It is lighter and quieter, uses less air And gives long service and high Performance. An excellent choice For the first gun in your shop.

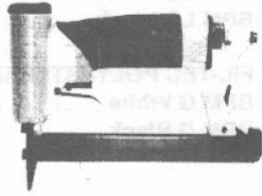

**ORDER BEA 7.....**

**STAR BITS AND HOLDER**

These 5/16" Hex Insert Bits are used for removing seat belts. T-45 is used for Ford And T-50 is used for General Motors. Made of a special high grade tool steel with a black oxide finish and heat treated for strength and durability.



**ORDER T45 Bit.....**  
**ORDER T50 Bit.....**

**VEEMO POLYMATIC THREAD (Size FF)**

Polyester thread is resistant to sunlight and mild acids for long life in outdoor seams. It remains strong and durable upon prolonged or frequent exposure to acids, bleach or other oxidizing agents, organic solvents and micro-organisms.

Available in 1 Lb. Cones.

**ORDER**

**Nymo LB FF Black .....**  
**Nymo LB FF White.....**

**Price  
 Per cone**

**NYMO UVR THREAD**

Special Ultra-violet ray resistant yard suitable For all automotive and indoor sewing requiring resistance to sunlight and weathering. Provides Seam strength, abrasion resistance, tensile Strength and sewability



**Size EE Nymo UVR (92) (cones)**

**ORDER NYMO LB or 6 oz and color 6 oz lb**  
**Black.....**  
**Natural.....**  
**White.....**

**Nymo 30 White or Black**

3 oz "0" White Nymo ideal for light upholstery and drapery.  
 Price per cone White.....  
 Price per cone Black.....

**Nymo EX - Size 8** monocord nylon thread provides seam strength, abrasion resistance, tensile strength and sewability **For indoor use only.** Available in Black or Ash.

**ORDER NYMO 8 ASH** (5500 Yard spool)..... **"DISC"**  
**ORDER NYMO 8 BLACK** (4400 Yard spool).... **"DISC"**

**NYMO BOBBINS**

Style A & G Bobbins  
 Style M Bobbins  
 24 yds. per bobbin/50  
 38 yds. per bobbin  
 bobbins per box  
 56 bobbins per box



**ORDER Price Per Box**

**Nymo G Natural.....**  
**Nymo M Natural.....**  
**Nymo G White.....**  
**Nymo M White.....**  
**Nymo G Black.....**  
**Nymo M Black.....**



Beaver	Black	Beaver
Black	Black	Black
Black	Black	Black
Black	Black	Black
Black	Black	Black
Black	Black	Black
Black	Black	Black
Black	Black	Black
Black	Black	Black
Black	Black	Black

**THE GF LINE FOR YOUR THREAD AND BOBBINS-TOLL FREE 1-800-237-6677**

**FIL-TEC THREAD Size 92 (EE)**

This bonded nylon monocord thread has a higher UVR resistance. This enables it to have a higher degree of strength in outdoor exposure. Use this product for both double needle and multi-directional operations. It stands up better to flexing and abrasion 2 to 1 polyester.  
( 1 lb. cones)

**ORDER**

- BNM LB Black**.....  
**BNM LB Ash (Natural)** .....  
**BNM LB White** .....

Price  
Per Cone

**FIL-TEC BOBBINS**

**Sideless bobbins** provide 12-15% more yardage per bobbin that traditional bobbins with paper sides.  
 Style G bobbins 34 yds. per bobbin. 72 bobbins per box.  
 Style M bobbins 52 yds. per bobbin. 72 bobbins per box.

**ORDER.**

- BNM G White** .....  
**BNM G Ash (Natural)**.....  
**BNM G Black**.....  
**BNM M White**.....  
**BNM M Ash (Natural)**.....  
**BNM M Black**.....

**HAND STITCHING TWINE**

2 oz. tubes---8 tubes per box. Available in following colors

- |              |                |              |              |             |
|--------------|----------------|--------------|--------------|-------------|
| <b>Beige</b> | <b>Caramel</b> | <b>Brown</b> | <b>Slate</b> | <b>Navy</b> |
| <b>Red</b>   | <b>Black</b>   | <b>White</b> | <b>Green</b> |             |

**Order Twine and the color desired** ..... ea  
 Per 8 Tubes..... ea

**TUFTING TWINE-HOLD FAST-**

A high tenacity, 3-ply twisted nylon cord; bonding prevents frayed ends and flaking. White, 80 lb. breaking strength. Prox 2100 feet (700 yd rolls).

**ORDER Twine Tuft**

1 lb. ....



**HEMP SPRING TWINE**

60/6 Hemp Ruby. 4 ply, Polished Hemp Spring Twine. Imported and made of highest quality. Seat springs tied with this twine will provide more years of use. Prox 250 ft. per lb. available in 1lb. or 5 lb. ball  
 50 lb. reel available on special order.

**ORDER TWINE SPRING**

1 lb. ball.....  
 5 lb. ball.....



**FIL-TEC UVR POLYESTER BONDED THREAD  
 SIZE 92 1 IB. CONES BONDED POLYESTER**

**ORDER**

- BPM LB White**.....  
**BPM LB Black**.....

**FIL-TEC POLYESTER BOBBINS**

- BPM G White**.....  
**BPM G Black**.....

**SUNGUARD-UVR POLYESTER BONDED THREAD**

Size F 8oz spools 100% Polyester thread  
 Great for indoor or outdoor applications

**ORDER**

**BTS 8 (COLOR)**

- |                  |                     |                       |
|------------------|---------------------|-----------------------|
| <b>Black</b>     | <b>Med Titanium</b> | <b>Shamrock Green</b> |
| <b>Blue Wave</b> | <b>Mocha</b>        | <b>Shark</b>          |
| <b>Cardinal</b>  | <b>Oyster</b>       | <b>Sunflower</b>      |
| <b>Dk Teal</b>   | <b>Pacific</b>      | <b>Sunglow Orange</b> |
| <b>Graphite</b>  | <b>Pearl</b>        | <b>Taupe</b>          |
| <b>Lilac</b>     | <b>Saddle</b>       | <b>White</b>          |
| <b>Med Opal</b>  | <b>Sand</b>         |                       |

**SUNGUARD-UVR POLYESTER BONDED BOBBINS**

Size G 72 Bobbins per box 25 yds per bobbin

**ORDER**

- BTS G BLACK**.....  
**BTS G WHITE**.....  
**BTS G SAND**.....

Size M 72 Bobbins per box 36 yds per bobbin

**ORDER**

- BTS M BLACK**.....  
**BTS M WHITE**.....  
**BTS M SAND**.....

**QTC NYLON BONDED THREAD**

#69 furniture thread 4 oz spools

- |                 |                    |                 |
|-----------------|--------------------|-----------------|
| <b>Beaver</b>   | <b>Dk Green</b>    | <b>Scarlet</b>  |
| <b>Black</b>    | <b>Leaf</b>        | <b>Slate</b>    |
| <b>Bluebell</b> | <b>Marine Blue</b> | <b>Toboggan</b> |
| <b>Brown</b>    | <b>Red</b>         | <b>White</b>    |
| <b>Cream</b>    | <b>Rose</b>        | <b>Wine</b>     |

**THE GF LINE FOR YOUR TUFTING TWINE TOLL FREE 1-800-237-6677**

**MONOFILAMENT THREAD AND BOBBINS-(Available in clear only)**

Size (mil)	Diameter	Cotton Thread	Tensile Strength Equivalent (lbs.)	Average Yield (yds./lb)	General Applications	Price-Nylon per lb. (approx. 2 lb. can)
#63(16/4)	11	16/4	8.0	7,100	Boots, saddles, Carpets, rugs, awnings, sail cloth, canvas, tapestry	

**ORDER Mono 63**



**MONOFILAMENT BOBBINS**

Size #40- Style G. Pre-wound bobbins are packed 100 per box. Available in clear. 25 yds per bobbin. Available in clear

**ORDER Mono G40**

**KLINCH-IT TOOL**

Klinch-it lowers your production cost and increases your production by speeding up one of your greatest time consuming operations. It eliminates the slow old fashioned method of sewing springs to the web base. Instead the springs are permanently fastened with sturdy steel clips.

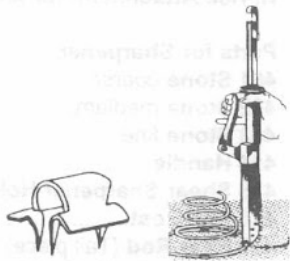

**ORDER Klinch-it Tool... \*\*SPECIAL ORDER\*\*...**

**ORDER Klinch-it Fasteners.....5000 Per box**

**ROCKER SWIVEL WITH LEGS**

All rocker swivels have brown legs with brown plastic feet. All have 1/4" front to back pitch. All have 5 coil rocker construction and ball bearing swivel action. Each rocker swivel has 8 ball bearings. 6" overall height at front 25" diameter leg span.



**ORDER Swivel 512 RS 6" Rocker Swivel.....**

Each.....

Ea. per carton (6) ....

**SWIVELS WITH LEGS-Swivel plate**

is level-no pitch. All swivels with legs have brown colored legs with brown plastic feet. Ball bearings provide smooth action.

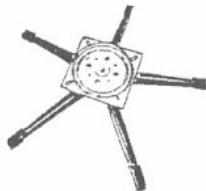

**ORDER Swivel 512-3 5/8" with legs ..... Ea.**

Each per carton (10) .....Ea.

**SWIVEL PLATES-Swivel plate is**

level-no pitch. Ball bearings provide smooth action. 5/8" high and 7 1/2" square top and bottom.



**ORDER Swivel 75 Flat .....**

Each per carton (12)

**GLIDES**

Torlon plastic glides for furniture. Available in 3/4" or 7/8". Packed 100 to the box.



**ORDER Torlon 3/4".....**

**ORDER Torlon 7/8".....**

Less 10% on 10 boxes or more

**THE GF LINE FOR YOUR CUTTING REQUIREMENTS-TOLL FREE 800-237-6677**

**Bent Trimmers**

Handles are bent so that blades operate parallel to the material being cut. Ideal for cutting out patterns. No. 20 Full length 10". Cut length 4 3/4". No. 22 Full length 12". Cut length 6 11/2" Hot dropped-forged.



**ORDER 20** 10" Shear.....  
**ORDER 22** 12" Shear.....

**#1DS-Poultry, Auto Body & Florist Shears-Hot**

dropped-forged. Nickel plated blades. Short blades and long straight handles provide extra leverage for effortless cutting.



**ORDER 1DS**.....

**Industrial & Professional Dressmakers' Shears-**

#428 Hot drop-forged. Nickel plated blades. 8" length. Bent Trimmer.

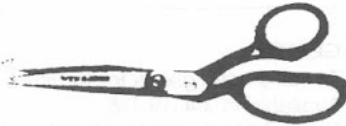

**ORDER 428**.....

**#20- Left Hand Industrial and Professional Shears-Hot drop-forged.**

Commercial finished blades. Black handles.



**ORDER 20LH** .....

**#1225 & #1226 Carpet, Upholstery & Fabric Shears-**

Hot drop-forged. Commercial finished blades. One blade is ground to a knife-edge for faster, cleaner, easier cutting of today's synthetic fabrics.



**ORDER 1225** 10" Knife Edge .....

**ORDER 1226** 12" Knife Edge .....

**Thread Clips**

For thread cutting, seam ripping and trimming. Lightweight and comfortable. Non-rusting stainless steel blades. Self opening spring for fast snipping. 4 5/8".



**ORDER TC1** Thread Clips.....

**SHARPENING STONE- for knife edge**

Soft Arkansas Whetstone. 1" X 3" packed in leather sheath. **ORDER GS**.....

**UNIVERSAL SHEAR SHARPENER**

- Now, a professional sharpening system that can be designed to suit your needs. This is guaranteed to develop a finer cutting edge than factory new shears or electric sharpeners.

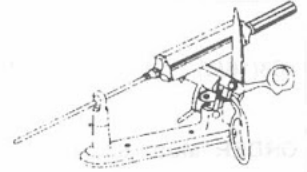

- Simple to operate.
  - Sharpens entire length of blade to any bevel.
  - Does not remove blade temper.
  - Great for pinking shears and thread clips.
  - Aluminum construction insures durability.
- Replacement or extra parts also available.

**ORDER SHARPENER** .....

**Hi-rise Attachment for knife edge shears (Special order)**

**Parts for Sharpener**

- 401** Stone coarse.....
- 402** Stone medium.....
- 403** Stone fine.....
- 414** Handle.....
- 415** Shear Sharpener Holder.....
- 416** Ball Post.....
- 419** Rear Rod (Tail piece).....
- 420** Hi-rise for Knife Edge.....

**MUNDIAL SHEARS**

**ORDER 420** 10" Bent Trimmer

**ORDER 422** 12" Bent Trimmer

**THE GF LINE FOR YOUR ZIPPERS TOLL FREE 1-800-237-6677**

**DELTRIN MARINE ZIPPER PVC**

ready made zipper, separating jacket. Matching 3/4" polyester tape and slides. Ideal for boat tops and curtains, Jeep Curtains and any outside use. Will not rust or corrode.

**#10 PVC Molded Tooth-**

**ORDER 10 White or Black and Length**

	Each	Per 10	Per 100
24".....			
36".....			
48".....			
54".....			
60".....			
72".....			
84".....			
96".....			
120".....			



**DELTRIN MARINE ZIPPER CHAIN**

PVC molded tooth, marine zipper chain. Available in black or white- cuts or rolls.

**#10 Chain.**

Per yd.- cut .....  
Per yd.- rolls (109 yds).....

**Each Per 100**

**#10 single pull slides (non-lock)**

**#10 double pull slides metal (non-lock)**

**#10 single pull slides plastic (auto-lock)**

**#10 double pull slides plastic (auto-lock)**

**#5 Marine zipper chain-PVC** molded tooth, marine zipper chain. Available in black or white- cuts or rolls.

Per yd.- cut .....  
Per yd.-rolls (218 yds).....

**Order 5 (color) Delrin**

**Pull Slides**

**Each per 100**

- #5 single pull slides (non-lock metal)
- #5 double pull slides (non-lock metal)
- #5 single pull slides (auto-lock plastic)
- #5 double pull slides (auto-lock plastic)

**#5 Zeplon zipper chain-**

Nylon coil closure, self mending zipper in white or beige.  
Per yd.- cut ... Per yd.-rolls (218 yds)....

**ORDER 5 Zeplon Color**

**Each Per 100**

- #5 single pull slides (non-lock)
- #5 double pull slides (non-lock)
- #5 single pull slides (auto-lock)
- #5 double pull slides (auto-lock)

**ZIPPERS READY MADE**

**No. 4 7/16" Tape or No. 5 9/16" Tape-**Brass ready made zippers for furniture and automotive. Available in beige or white tape, by each, per 50 or per 100. Prices of 50 or more .

**ORDER 4 Brass and Size**

100		
12".....	27".....	
15".....	30".....	
21".....	36".....	
24".....	48".....	

**ORDER 5 Brass and Size Ea. Ea. Per 50 Ea. Per 100**

12".....	
15".....	
18".....	
21".....	
24".....	
27".....	
30".....	
36".....	
42".....	
48".....	
60".....	
72".....	
84".....	

**Zipper chain-** Available in aluminum or brass, cuts or by the roll. Tan or white tape. #4, #5, & #7 Zipper.

	Cuts	Rolls
#4 Aluminum	per yd.	
#5 Aluminum	per yd.	
#7 Brass (tan or blk.)	per yd.	



- #4, #5, & #7 Zipper in full roll
- #4 Aluminum 250 yds. (Includes 200 steel slides)
- #5 Aluminum 150 yds. (Includes 150 steel slides)
- #4, #5 & #7 Slides- Top & Bottom Stops

**Per roll**

- #4 & #5 Top & Bottom Stops (brass)
- #4 Slides Brass (non-rust or nickel)
- #4 Slides Steel
- #5 Slides Brass (non-rust or nickel)
- #5 Slides Steel
- #7 Top & Bottom Stops
- #7 Slides Brass Single (non-lock)
- #7 Slides Brass Double (non-lock)

**Each Per 100**

**COIL FURNITURE ZIPPER CHAIN**

Per yd cut or roll (218 yds) 5/8" chain  
**#4.5 White or Beige coil**

**#4.5 Single slides**





















































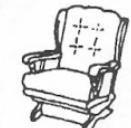

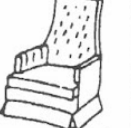
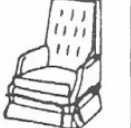

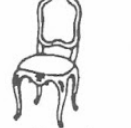
**Each Per 100**

**COIL MARINE ZIPPER CHAIN**

Per yd cut or roll  
**#10 White coil - 109 yards 3/4" chain**  
**#10 Black coil - 109 yards 3/4" chain**

- #10 Single slides White or Black
- #10 Double slides White or Black

**Each Per 100**  
**Each Per 100**

 5 yds	 34 yds	 6' 10 yds 7' 11 yds 9' 13 yds	 6' 10 yds 7' 11 yds 9' 13 yds	 6' 10 yds 7' 11 yds 9' 13 yds	 6' 12 yds 7' 14 yds 9' 16 yds	 14 yds	 16 yds	 11 yds	 11 yds
 12 yds	 10 yds	 10 yds	 2½ yds	 6 yds	 6 yds	 4 yds	 13 yds	 3 yds	 5½ yds
 5 yds	 6½ yds	 5½ yds	 6' 16 yds	 6 yds	 6 yds	 4 yds	 7 yds	 2½ yds	 3 yds
 7½ yds	 2½ yds	 4 yds	 7 yds	 5 yds	 5 yds	 6½ yds	 5 yds	 8 yds	 4 yds
 5 yds	 4½ yds	 7 yds	 3½ yds	 6 yds	 6 yds	 6½ yds	 6½ yds	 2½ yds	 1½ yds
 5 yds	 1½ yds	 1½ yds	 2½ yds	 1½ yds	 3½ yds	 4½ yds	 4½ yds	 4½ yds	 2½ yds

*If you don't see what you need ask us!*

## Distributors Of:

- Alcantara Automotive Suede
- Aqua-tex II
- Ardwin Bindings
- Au-ve-co Products
- BEA (Stan-Tec) Staplers
- Bostitch Stapling Products
- Carpet (non woven)
- CMI Headliner & Vinyl
- Conso Trimmings
- C. S. Osborne Co. Tools
- Detroit Body Products
- DOT Fasteners
- Duo-Fast Staplers
- Dunlap Industrues
- Empire Staplers
- Fil-Tec Thread
- Futura Vinyls
- Herculite
- Jiffy Steamers
- Johnson Industries
- Leisure Time Fabrics
- Misty Adhesive
- Gingher Shears
- Handy Buttons
- Herculite
- NASSIMI Vinyls
- Nymo Coats American Thread.(NYMO)
- Pinnacle Sales
- Phifertex
- Pres N Snap Tools
- SEM Products
- Spradling International
- Spradling Originals
- Ultrasuede® Ambiance
- Ultraleather™ Products
- Vicar
- Sprayway Vinyl Cleaners
- Sun Guard Thread
- Weldwood Contact Cement
- Wiss Shears
- YKK -USA Zippers
- And More

  **Visa/MasterCard Accepted**

 **ASIA AUTO TRIM**  
WHOLESALEERS DIVISION

